

Available Configurations

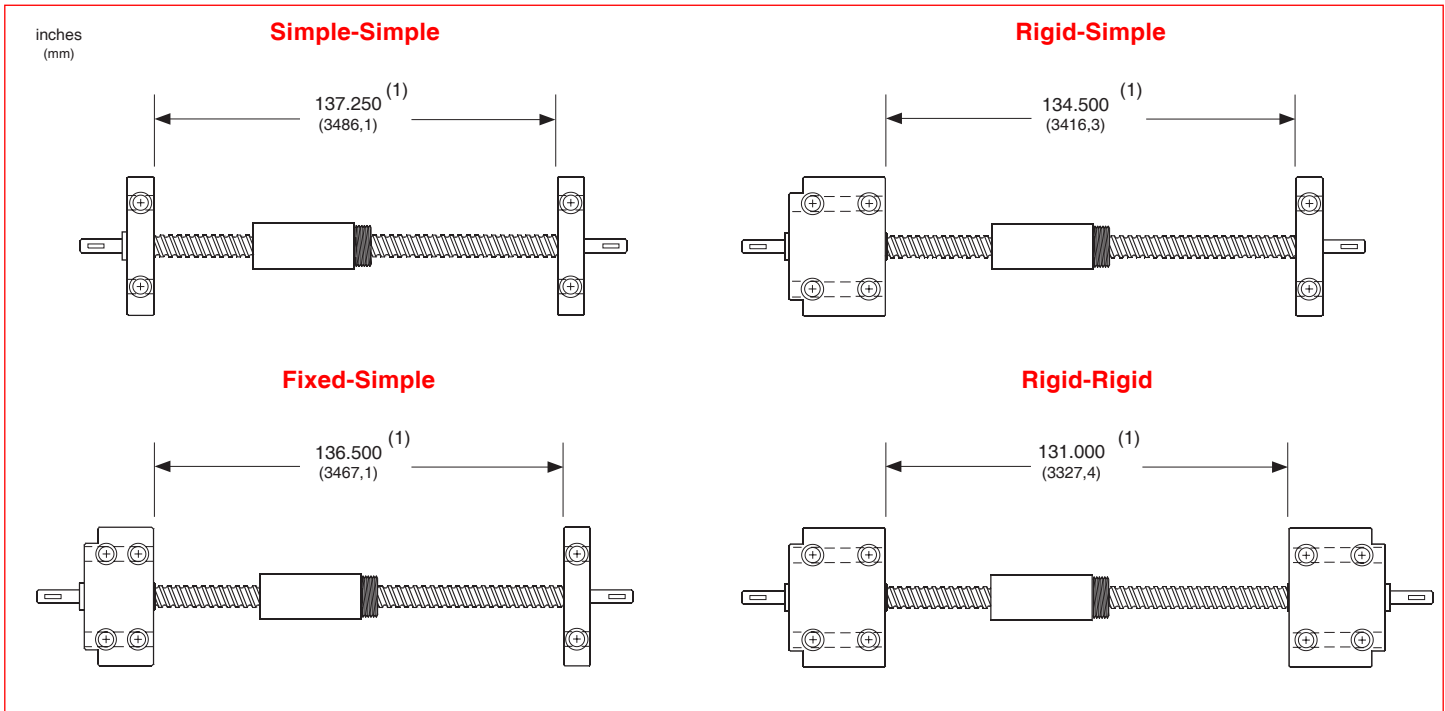

Overall Length Diagram

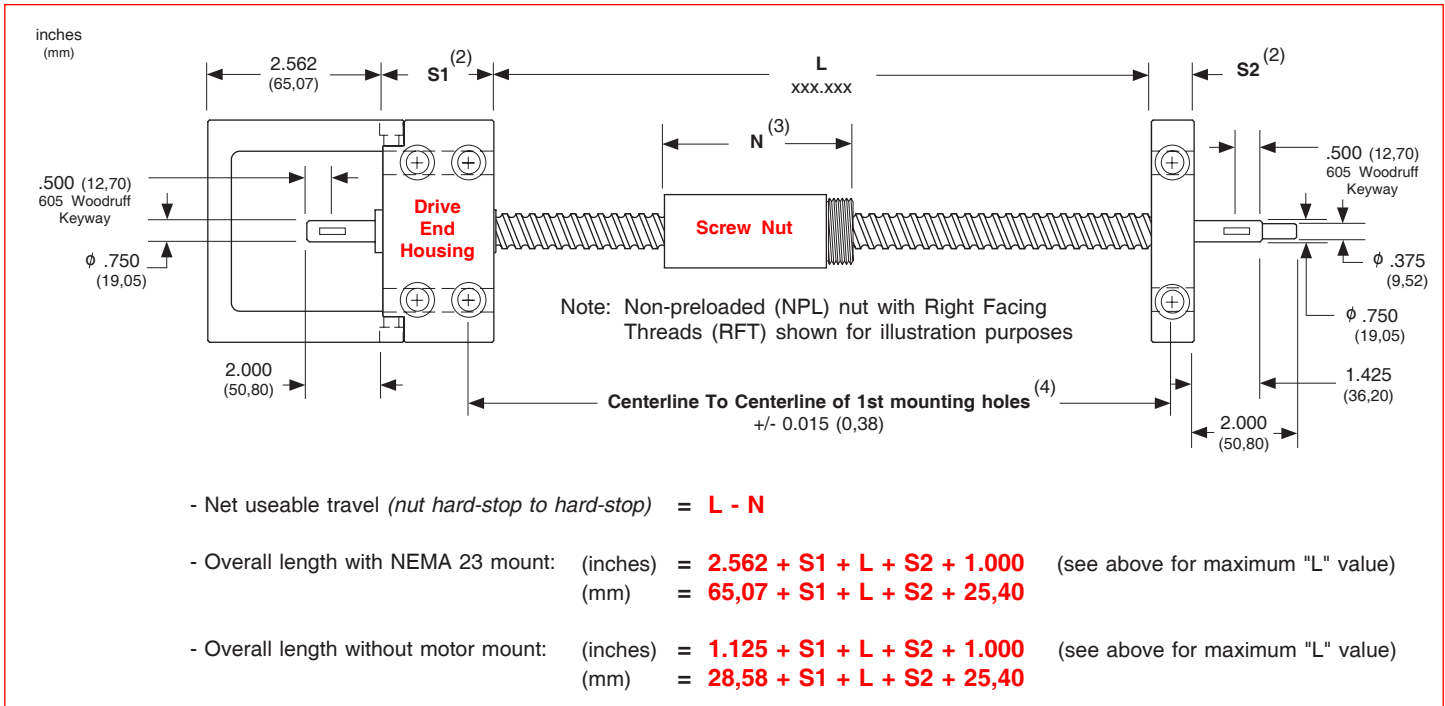

Footnotes:

- (1) Maximum available standard screw thread length for the bearing support housing configuration shown.
- (2) Fixed-simple support configuration shown for reference. See page 61 for length values for simple, fixed, and rigid housings.
- (3) See page 60 for available nut styles. Refer to A1 & A2 values for the nut length. See page 96 for wiper kit lengths.
- (4) Tolerance shown is for base mounted support housings. Tolerance also applies to face mounted support housings.