

**TRSA** **12** - **6** - **SS** - **E4**

**Assembly Type** \_\_\_\_\_

**SA** - Single rail shaft assembly

**TRSA** - *TWIN RAIL*® shaft assembly

**Shaft Diameter** \_\_\_\_\_

**8** - 0.500 inch diameter

**10** - 0.625 inch diameter

**12** - 0.750 inch diameter

**16** - 1.000 inch diameter

**20** - 1.250 inch diameter

**24** - 1.500 inch diameter

**32** - 2.000 inch diameter

**Overall Length** \_\_\_\_\_

**xxx** - inches

**Shaft Material** \_\_\_\_\_

- 1060 Steel

**SS** - 440C Stainless Steel

**CR** - Chrome Plated 1060 Steel

**End Stops** \_\_\_\_\_

- No end stops

**E1** - One end stop

**E2** - Two end stops

**E3** - Three end stops

**E4** - Four end stops

### Specifications: SA & TRSA Shaft Assemblies

<b>Support Type &amp; Finish</b>	Precision Machined 6061-T6 Aluminum, Black Anodized		
<b>Shaft Straightness</b>	0.001/0.002 in/ft, cumulative		
<b>Shaft Parallelism (TRSA only)</b>	+/- 0.002 in overall		
<b>Shaft Type</b>	SL - 1060 Steel or 440C Stainless steel		
<b>Shaft Roundness</b>	0.000080 inches		
<b>Shaft Chamfer</b>	For 0.50 - 0.75 inch dia. : 0.03 inch x 45°, For 1.00 - 2.00 inch dia. : 0.06 inch x 45°		
<b>Surface Finish</b>	8 - 12 R <sub>a</sub> microinch		
<b>Diameter Tolerance</b>	<b>Nominal Shaft Diameter</b>	<b>Shaft Diameter Tolerance</b>	<b>Minimum Hardness Depth</b>
<b>Hardness Depth</b>	(inches)	(inches)	(inches)
	0.500	.4995 / .4990	0.040
	0.625	.6245 / .6240	0.040
	0.750	.7495 / .7490	0.060
	1.000	.9995 / .9990	0.080
	1.250	1.2495 / 1.2490	0.080
	1.500	1.4994 / 1.4989	0.080
	2.000	1.9994 / 1.9987	0.100

## Dimensions & Specifications: TRSA TWIN RAIL® Shaft Assembly

Model Number	Nominal Shaft Diameter (inches)	Overall Length (inches)	Dimensions (inches)											Assembly Weight (lbs)
			A +/- .002	B +/- .002	C	D	E +/- .010	F	G	H	J hole	K Bolt Size	L <sup>(2)</sup> Thread	
TRSA8-6	0.500	6	1.125	3.000	3.750	0.875	2.000	.375	.312	.250	.169	#6-32	#10-32	1.8
TRSA10-6	0.625	6	1.125	3.750	4.625	1.000	2.625	.437	.312	.312	.193	#8-32	#10-32	2.4
TRSA12-6	0.750	6	1.500	4.500	5.500	1.125	3.250	.500	.312	.375	.221	#10-32	#10-32	3.4
TRSA16-6	1.000	6	1.750	5.250	6.375	1.312	3.750	.562	.312	.500	.281	1/4-20	#10-32	5.0
TRSA20-6 <sup>(1)</sup>	1.250	6	2.125	6.000	7.250	1.562	4.125	.625	.375	.562	.281	1/4-20	1/4-20	7.5
TRSA24-6 <sup>(1)</sup>	1.500	6	2.500	6.625	8.125	1.875	4.375	.750	.437	.687	.343	5/16-18	5/16-18	10.5
TRSA32-6 <sup>(1)</sup>	2.000	6	3.250	7.250	9.000	2.250	4.500	.875	.562	.875	.406	3/8-16	3/8-16	15.7
TRSA8-12	0.500	12	1.125	3.000	3.750	0.875	2.000	.375	.312	.250	.169	#6-32	#10-32	3.6
TRSA10-12	0.625	12	1.125	3.750	4.625	1.000	2.625	.437	.312	.312	.193	#8-32	#10-32	4.8
TRSA12-12	0.750	12	1.500	4.500	5.500	1.125	3.250	.500	.312	.375	.221	#10-32	#10-32	6.8
TRSA16-12	1.000	12	1.750	5.250	6.375	1.312	3.750	.562	.312	.500	.281	1/4-20	#10-32	10.0
TRSA20-12	1.250	12	2.125	6.000	7.250	1.562	4.125	.625	.375	.562	.281	1/4-20	1/4-20	15.0
TRSA24-12	1.500	12	2.500	6.625	8.125	1.875	4.375	.750	.437	.687	.343	5/16-18	5/16-18	21.0
TRSA32-12 <sup>(1)</sup>	2.000	12	3.250	7.250	9.000	2.250	4.500	.875	.562	.875	.406	3/8-16	3/8-16	31.3
TRSA8-18	0.500	18	1.125	3.000	3.750	0.875	2.000	.375	.312	.250	.169	#6-32	#10-32	5.4
TRSA10-18	0.625	18	1.125	3.750	4.625	1.000	2.625	.437	.312	.312	.193	#8-32	#10-32	7.2
TRSA12-18	0.750	18	1.500	4.500	5.500	1.125	3.250	.500	.312	.375	.221	#10-32	#10-32	10.1
TRSA16-18	1.000	18	1.750	5.250	6.375	1.312	3.750	.562	.312	.500	.281	1/4-20	#10-32	15.0
TRSA20-18	1.250	18	2.125	6.000	7.250	1.562	4.125	.625	.375	.562	.281	1/4-20	1/4-20	22.4
TRSA24-18	1.500	18	2.500	6.625	8.125	1.875	4.375	.750	.437	.687	.343	5/16-18	5/16-18	31.4
TRSA32-18 <sup>(1)</sup>	2.000	18	3.250	7.250	9.000	2.250	4.500	.875	.562	.875	.406	3/8-16	3/8-16	46.9
TRSA8-24	0.500	24	1.125	3.000	3.750	0.875	2.000	.375	.312	.250	.169	#6-32	#10-32	7.2
TRSA10-24	0.625	24	1.125	3.750	4.625	1.000	2.625	.437	.312	.312	.193	#8-32	#10-32	9.6
TRSA12-24	0.750	24	1.500	4.500	5.500	1.125	3.250	.500	.312	.375	.221	#10-32	#10-32	13.5
TRSA16-24	1.000	24	1.750	5.250	6.375	1.312	3.750	.562	.312	.500	.281	1/4-20	#10-32	20.0
TRSA20-24	1.250	24	2.125	6.000	7.250	1.562	4.125	.625	.375	.562	.281	1/4-20	1/4-20	29.9
TRSA24-24	1.500	24	2.500	6.625	8.125	1.875	4.375	.750	.437	.687	.343	5/16-18	5/16-18	41.9
TRSA32-24	2.000	24	3.250	7.250	9.000	2.250	4.500	.875	.562	.875	.406	3/8-16	3/8-16	62.5
TRSA8-30	0.500	30	1.125	3.000	3.750	0.875	2.000	.375	.312	.250	.169	#6-32	#10-32	9.0
TRSA10-30	0.625	30	1.125	3.750	4.625	1.000	2.625	.437	.312	.312	.193	#8-32	#10-32	12.0
TRSA12-30	0.750	30	1.500	4.500	5.500	1.125	3.250	.500	.312	.375	.221	#10-32	#10-32	16.8
TRSA16-30	1.000	30	1.750	5.250	6.375	1.312	3.750	.562	.312	.500	.281	1/4-20	#10-32	25.0
TRSA20-30	1.250	30	2.125	6.000	7.250	1.562	4.125	.625	.375	.562	.281	1/4-20	1/4-20	37.3
TRSA24-30	1.500	30	2.500	6.625	8.125	1.875	4.375	.750	.437	.687	.343	5/16-18	5/16-18	52.3
TRSA32-30	2.000	30	3.250	7.250	9.000	2.250	4.500	.875	.562	.875	.406	3/8-16	3/8-16	78.1

### Footnotes:

(1) Not a stock item, but available upon request.

(2) Two threaded leveling holes per TWIN RAIL® support segment are used for setscrew adjustment to aid in assembly leveling to the user mounting surfaces.

Specifications subject to change without notice

Dimensions

(inches)

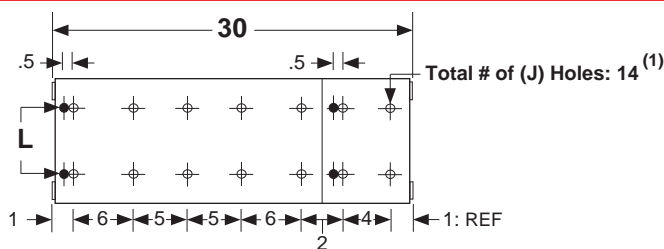
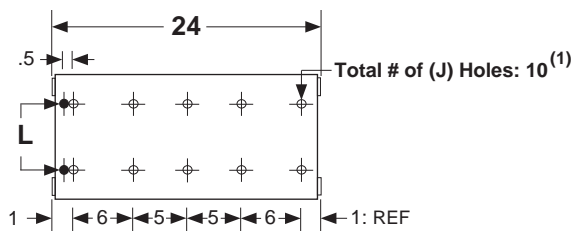
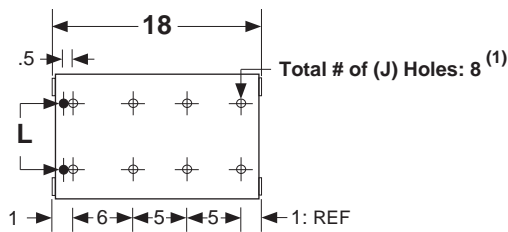
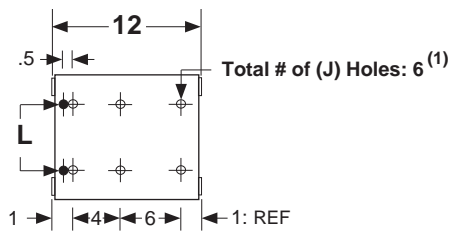
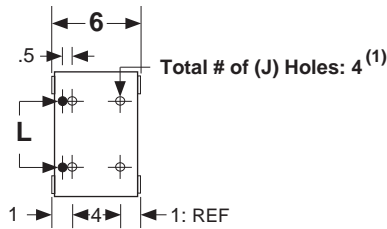
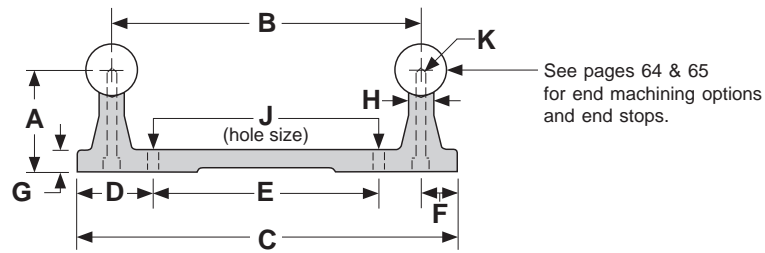

Footnotes:

(1) TWIN RAIL® supports come in 6, 12, 18 and 24 inch segments. The mounting hole location linear tolerance is +/- .010 inches noncumulative per segment. The supports are not one piece for lengths over 24 inches. The mounting hole linear tolerance is +/- .015 inches cumulative from one support segment to the next.

## Dimensions & Specifications: TRSA TWIN RAIL® Shaft Assembly

Model Number	Nominal Shaft Diameter (inches)	Overall Length (inches)	Dimensions (inches)											Assembly Weight (lbs)
			A +/- .002	B +/- .002	C	D	E +/- .010	F	G	H	J hole	K Bolt Size	L <sup>(1)</sup> Thread	
TRSA8-36	0.500	36	1.125	3.000	3.750	0.875	2.000	.375	.312	.250	.169	#6-32	#10-32	10.8
TRSA10-36	0.625	36	1.125	3.750	4.625	1.000	2.625	.437	.312	.312	.193	#8-32	#10-32	14.4
TRSA12-36	0.750	36	1.500	4.500	5.500	1.125	3.250	.500	.312	.375	.221	#10-32	#10-32	20.2
TRSA16-36	1.000	36	1.750	5.250	6.375	1.312	3.750	.562	.312	.500	.281	1/4-20	#10-32	30.0
TRSA20-36	1.250	36	2.125	6.000	7.250	1.562	4.125	.625	.375	.562	.281	1/4-20	1/4-20	44.8
TRSA24-36	1.500	36	2.500	6.625	8.125	1.875	4.375	.750	.437	.687	.343	5/16-18	5/16-18	62.8
TRSA32-36	2.000	36	3.250	7.250	9.000	2.250	4.500	.875	.562	.875	.406	3/8-16	3/8-16	93.7
TRSA8-42	0.500	42	1.125	3.000	3.750	0.875	2.000	.375	.312	.250	.169	#6-32	#10-32	12.6
TRSA10-42	0.625	42	1.125	3.750	4.625	1.000	2.625	.437	.312	.312	.193	#8-32	#10-32	16.7
TRSA12-42	0.750	42	1.500	4.500	5.500	1.125	3.250	.500	.312	.375	.221	#10-32	#10-32	23.6
TRSA16-42	1.000	42	1.750	5.250	6.375	1.312	3.750	.562	.312	.500	.281	1/4-20	#10-32	35.0
TRSA20-42	1.250	42	2.125	6.000	7.250	1.562	4.125	.625	.375	.562	.281	1/4-20	1/4-20	52.3
TRSA24-42	1.500	42	2.500	6.625	8.125	1.875	4.375	.750	.437	.687	.343	5/16-18	5/16-18	73.2
TRSA32-42	2.000	42	3.250	7.250	9.000	2.250	4.500	.875	.562	.875	.406	3/8-16	3/8-16	109.3
TRSA8-48	0.500	48	1.125	3.000	3.750	0.875	2.000	.375	.312	.250	.169	#6-32	#10-32	14.4
TRSA10-48	0.625	48	1.125	3.750	4.625	1.000	2.625	.437	.312	.312	.193	#8-32	#10-32	19.1
TRSA12-48	0.750	48	1.500	4.500	5.500	1.125	3.250	.500	.312	.375	.221	#10-32	#10-32	26.9
TRSA16-48	1.000	48	1.750	5.250	6.375	1.312	3.750	.562	.312	.500	.281	1/4-20	#10-32	40.0
TRSA20-48	1.250	48	2.125	6.000	7.250	1.562	4.125	.625	.375	.562	.281	1/4-20	1/4-20	59.7
TRSA24-48	1.500	48	2.500	6.625	8.125	1.875	4.375	.750	.437	.687	.343	5/16-18	5/16-18	83.7
TRSA32-48	2.000	48	3.250	7.250	9.000	2.250	4.500	.875	.562	.875	.406	3/8-16	3/8-16	124.9
TRSA8-54	0.500	54	1.125	3.000	3.750	0.875	2.000	.375	.312	.250	.169	#6-32	#10-32	16.2
TRSA10-54	0.625	54	1.125	3.750	4.625	1.000	2.625	.437	.312	.312	.193	#8-32	#10-32	21.5
TRSA12-54	0.750	54	1.500	4.500	5.500	1.125	3.250	.500	.312	.375	.221	#10-32	#10-32	30.3
TRSA16-54	1.000	54	1.750	5.250	6.375	1.312	3.750	.562	.312	.500	.281	1/4-20	#10-32	45.0
TRSA20-54	1.250	54	2.125	6.000	7.250	1.562	4.125	.625	.375	.562	.281	1/4-20	1/4-20	67.2
TRSA24-54	1.500	54	2.500	6.625	8.125	1.875	4.375	.750	.437	.687	.343	5/16-18	5/16-18	94.1
TRSA32-54	2.000	54	3.250	7.250	9.000	2.250	4.500	.875	.562	.875	.406	3/8-16	3/8-16	140.5
TRSA8-60	0.500	60	1.125	3.000	3.750	0.875	2.000	.375	.312	.250	.169	#6-32	#10-32	18.0
TRSA10-60	0.625	60	1.125	3.750	4.625	1.000	2.625	.437	.312	.312	.193	#8-32	#10-32	23.9
TRSA12-60	0.750	60	1.500	4.500	5.500	1.125	3.250	.500	.312	.375	.221	#10-32	#10-32	33.6
TRSA16-60	1.000	60	1.750	5.250	6.375	1.312	3.750	.562	.312	.500	.281	1/4-20	#10-32	49.9
TRSA20-60	1.250	60	2.125	6.000	7.250	1.562	4.125	.625	.375	.562	.281	1/4-20	1/4-20	74.6
TRSA24-60	1.500	60	2.500	6.625	8.125	1.875	4.375	.750	.437	.687	.343	5/16-18	5/16-18	104.6
TRSA32-60	2.000	60	3.250	7.250	9.000	2.250	4.500	.875	.562	.875	.406	3/8-16	3/8-16	156.1

### Footnotes:

(1) Two threaded leveling holes per TWIN RAIL® support segment are used for setscrew adjustment to aid in assembly leveling to the user mounting surfaces.

Dimensions

(inches)

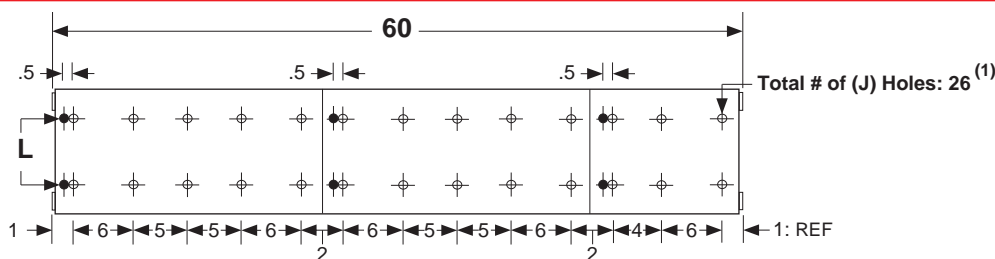
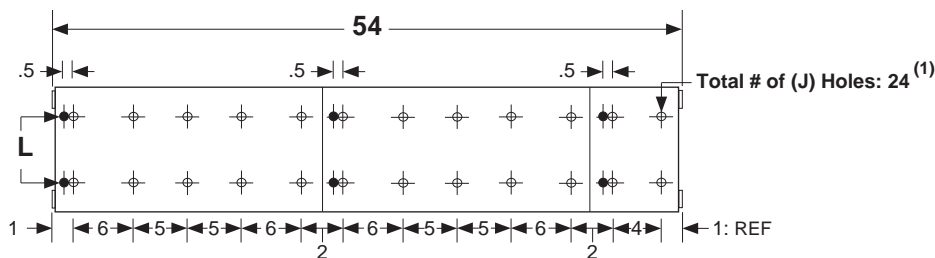
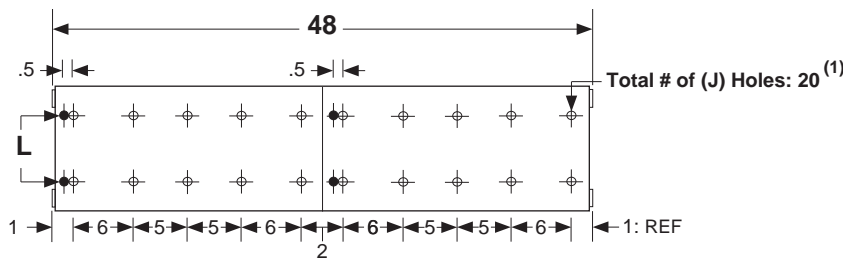
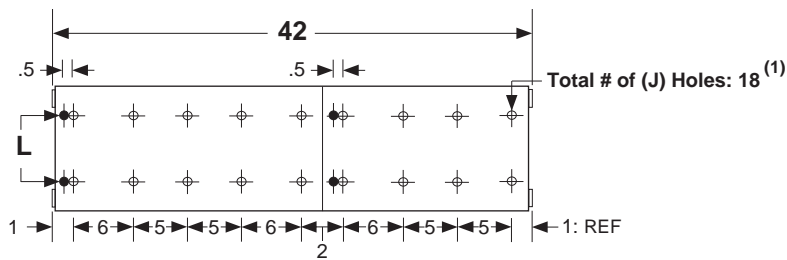
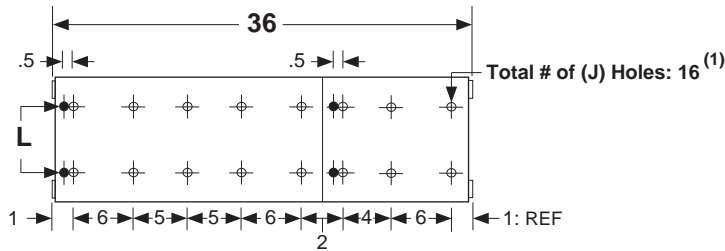
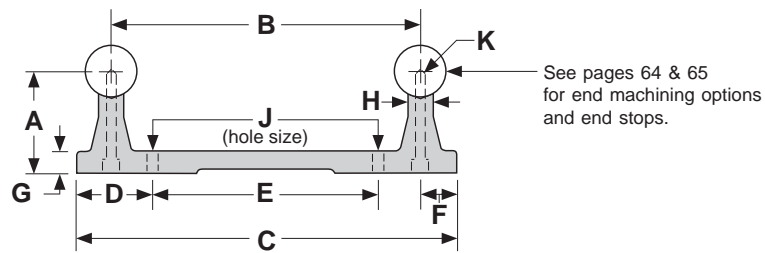

Footnotes:

(1) TWIN RAIL® supports come in 6, 12, 18 and 24 inch segments. The mounting hole location linear tolerance is +/- .010 inches noncumulative per segment. The supports are not one piece for lengths over 24 inches. The mounting hole linear tolerance is +/- .015 inches cumulative from one support segment to the next.

## Dimensions & Specifications: TRSA TWIN RAIL® Shaft Assembly

Model Number	Nominal Shaft Diameter (inches)	Overall Length (inches)	Dimensions (inches)											Assembly Weight (lbs)
			A +/- .002	B +/- .002	C	D	E +/- .010	F	G	H	J hole	K Bolt Size	L <sup>(1)</sup> Thread	
TRSA8-66	0.500	66	1.125	3.000	3.750	0.875	2.000	.375	.312	.250	.169	#6-32	#10-32	19.8
TRSA10-66	0.625	66	1.125	3.750	4.625	1.000	2.625	.437	.312	.312	.193	#8-32	#10-32	26.3
TRSA12-66	0.750	66	1.500	4.500	5.500	1.125	3.250	.500	.312	.375	.221	#10-32	#10-32	37.0
TRSA16-66	1.000	66	1.750	5.250	6.375	1.312	3.750	.562	.312	.500	.281	1/4-20	#10-32	54.9
TRSA20-66	1.250	66	2.125	6.000	7.250	1.562	4.125	.625	.375	.562	.281	1/4-20	1/4-20	82.1
TRSA24-66	1.500	66	2.500	6.625	8.125	1.875	4.375	.750	.437	.687	.343	5/16-18	5/16-18	115.1
TRSA32-66	2.000	66	3.250	7.250	9.000	2.250	4.500	.875	.562	.875	.406	3/8-16	3/8-16	171.8
TRSA8-72	0.500	72	1.125	3.000	3.750	0.875	2.000	.375	.312	.250	.169	#6-32	#10-32	21.6
TRSA10-72	0.625	72	1.125	3.750	4.625	1.000	2.625	.437	.312	.312	.193	#8-32	#10-32	28.7
TRSA12-72	0.750	72	1.500	4.500	5.500	1.125	3.250	.500	.312	.375	.221	#10-32	#10-32	40.4
TRSA16-72	1.000	72	1.750	5.250	6.375	1.312	3.750	.562	.312	.500	.281	1/4-20	#10-32	59.9
TRSA20-72	1.250	72	2.125	6.000	7.250	1.562	4.125	.625	.375	.562	.281	1/4-20	1/4-20	89.6
TRSA24-72	1.500	72	2.500	6.625	8.125	1.875	4.375	.750	.437	.687	.343	5/16-18	5/16-18	125.5
TRSA32-72	2.000	72	3.250	7.250	9.000	2.250	4.500	.875	.562	.875	.406	3/8-16	3/8-16	187.4
TRSA8-84	0.500	84	1.125	3.000	3.750	0.875	2.000	.375	.312	.250	.169	#6-32	#10-32	25.2
TRSA10-84	0.625	84	1.125	3.750	4.625	1.000	2.625	.437	.312	.312	.193	#8-32	#10-32	33.4
TRSA12-84	0.750	84	1.500	4.500	5.500	1.125	3.250	.500	.312	.375	.221	#10-32	#10-32	47.1
TRSA16-84	1.000	84	1.750	5.250	6.375	1.312	3.750	.562	.312	.500	.281	1/4-20	#10-32	69.9
TRSA20-84	1.250	84	2.125	6.000	7.250	1.562	4.125	.625	.375	.562	.281	1/4-20	1/4-20	104.5
TRSA24-84	1.500	84	2.500	6.625	8.125	1.875	4.375	.750	.437	.687	.343	5/16-18	5/16-18	146.4
TRSA32-84	2.000	84	3.250	7.250	9.000	2.250	4.500	.875	.562	.875	.406	3/8-16	3/8-16	218.6
TRSA8-96	0.500	96	1.125	3.000	3.750	0.875	2.000	.375	.312	.250	.169	#6-32	#10-32	28.8
TRSA10-96	0.625	96	1.125	3.750	4.625	1.000	2.625	.437	.312	.312	.193	#8-32	#10-32	38.2
TRSA12-96	0.750	96	1.500	4.500	5.500	1.125	3.250	.500	.312	.375	.221	#10-32	#10-32	53.8
TRSA16-96	1.000	96	1.750	5.250	6.375	1.312	3.750	.562	.312	.500	.281	1/4-20	#10-32	79.9
TRSA20-96	1.250	96	2.125	6.000	7.250	1.562	4.125	.625	.375	.562	.281	1/4-20	1/4-20	119.4
TRSA24-96	1.500	96	2.500	6.625	8.125	1.875	4.375	.750	.437	.687	.343	5/16-18	5/16-18	167.3
TRSA32-96	2.000	96	3.250	7.250	9.000	2.250	4.500	.875	.562	.875	.406	3/8-16	3/8-16	249.8
TRSA8-108	0.500	108	1.125	3.000	3.750	0.875	2.000	.375	.312	.250	.169	#6-32	#10-32	32.4
TRSA10-108	0.625	108	1.125	3.750	4.625	1.000	2.625	.437	.312	.312	.193	#8-32	#10-32	43.0
TRSA12-108	0.750	108	1.500	4.500	5.500	1.125	3.250	.500	.312	.375	.221	#10-32	#10-32	60.5
TRSA16-108	1.000	108	1.750	5.250	6.375	1.312	3.750	.562	.312	.500	.281	1/4-20	#10-32	89.9
TRSA20-108	1.250	108	2.125	6.000	7.250	1.562	4.125	.625	.375	.562	.281	1/4-20	1/4-20	134.3
TRSA24-108	1.500	108	2.500	6.625	8.125	1.875	4.375	.750	.437	.687	.343	5/16-18	5/16-18	188.2
TRSA32-108	2.000	108	3.250	7.250	9.000	2.250	4.500	.875	.562	.875	.406	3/8-16	3/8-16	281.0

### Footnotes:

(1) Two threaded leveling holes per TWIN RAIL® support segment are used for setscrew adjustment to aid in assembly leveling to the user mounting surfaces.

## Dimensions

(inches)

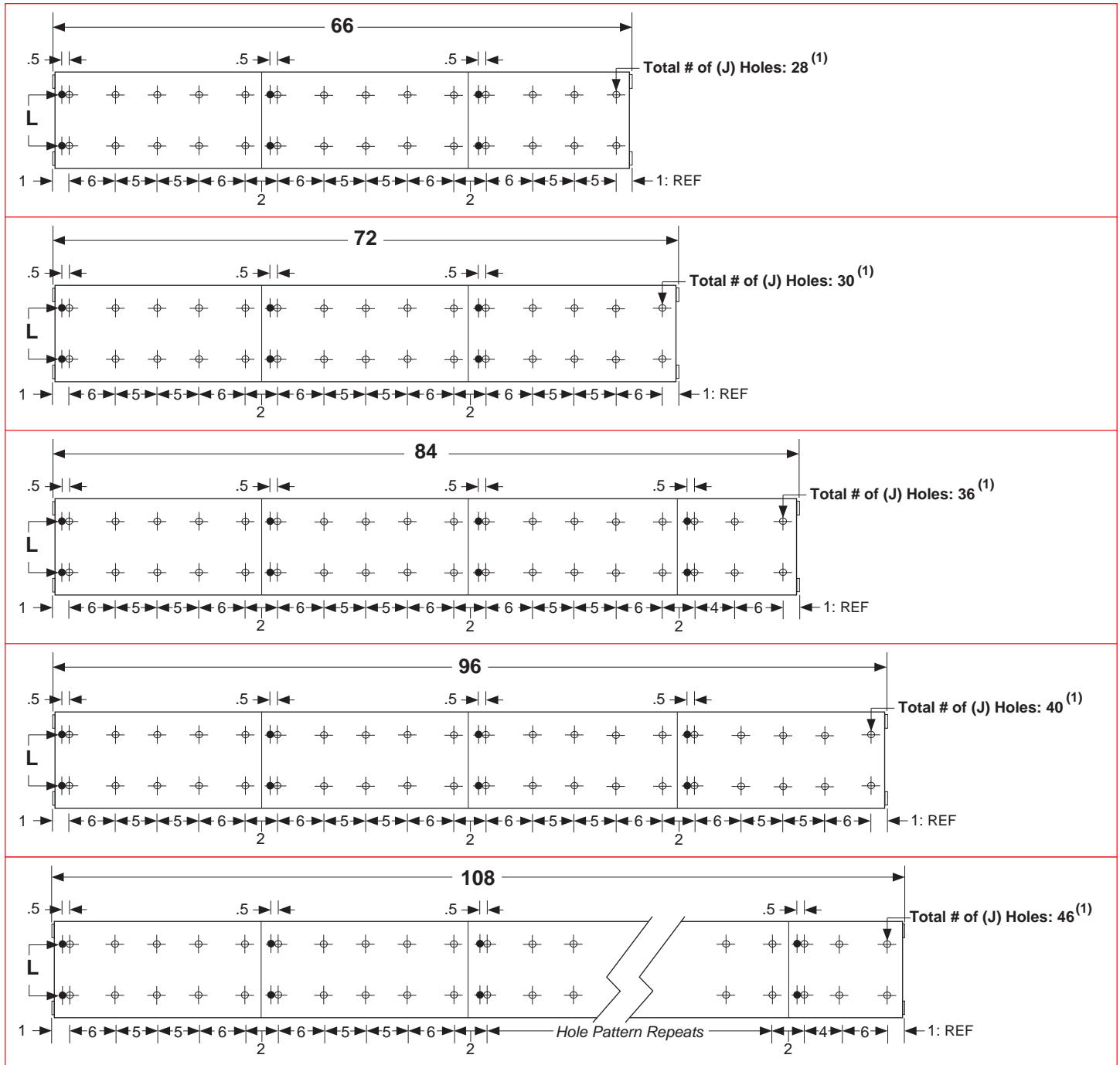
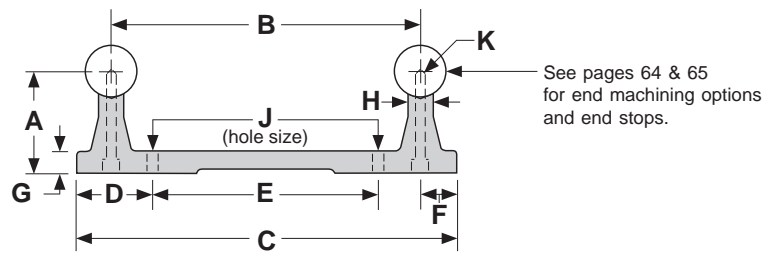

### Footnotes:

(1) TWIN RAIL® supports come in 6, 12, 18 and 24 inch segments. The mounting hole location linear tolerance is +/- .010 inches noncumulative per segment. The supports are not one piece for lengths over 24 inches. The mounting hole linear tolerance is +/- .015 inches cumulative from one support segment to the next.

## Dimensions & Specifications: TRSA TWIN RAIL® Shaft Assembly

Model Number	Nominal Shaft Diameter (inches)	Overall Length (inches)	Dimensions (inches)											Assembly Weight (lbs)
			A +/- .002	B +/- .002	C	D	E +/- .010	F	G	H	J hole	K Bolt Size	L <sup>(1)</sup> Thread	
TRSA8-120	0.500	120	1.125	3.000	3.750	0.875	2.000	.375	.312	.250	.169	#6-32	#10-32	35.9
TRSA10-120	0.625	120	1.125	3.750	4.625	1.000	2.625	.437	.312	.312	.193	#8-32	#10-32	47.7
TRSA12-120	0.750	120	1.500	4.500	5.500	1.125	3.250	.500	.312	.375	.221	#10-32	#10-32	67.2
TRSA16-120	1.000	120	1.750	5.250	6.375	1.312	3.750	.562	.312	.500	.281	1/4-20	#10-32	99.8
TRSA20-120	1.250	120	2.125	6.000	7.250	1.562	4.125	.625	.375	.562	.281	1/4-20	1/4-20	149.2
TRSA24-120	1.500	120	2.500	6.625	8.125	1.875	4.375	.750	.437	.687	.343	5/16-18	5/16-18	209.1
TRSA32-120	2.000	120	3.250	7.250	9.000	2.250	4.500	.875	.562	.875	.406	3/8-16	3/8-16	312.2
TRSA8-144	0.500	144	1.125	3.000	3.750	0.875	2.000	.375	.312	.250	.169	#6-32	#10-32	43.1
TRSA10-144	0.625	144	1.125	3.750	4.625	1.000	2.625	.437	.312	.312	.193	#8-32	#10-32	57.3
TRSA12-144	0.750	144	1.500	4.500	5.500	1.125	3.250	.500	.312	.375	.221	#10-32	#10-32	80.7
TRSA16-144	1.000	144	1.750	5.250	6.375	1.312	3.750	.562	.312	.500	.281	1/4-20	#10-32	119.8
TRSA20-144	1.250	144	2.125	6.000	7.250	1.562	4.125	.625	.375	.562	.281	1/4-20	1/4-20	179.1
TRSA24-144	1.500	144	2.500	6.625	8.125	1.875	4.375	.750	.437	.687	.343	5/16-18	5/16-18	251.0
TRSA32-144	2.000	144	3.250	7.250	9.000	2.250	4.500	.875	.562	.875	.406	3/8-16	3/8-16	374.7
TRSA12-168	0.750	168	1.500	4.500	5.500	1.125	3.250	.500	.312	.375	.221	#10-32	#10-32	94.1
TRSA16-168	1.000	168	1.750	5.250	6.375	1.312	3.750	.562	.312	.500	.281	1/4-20	#10-32	139.8
TRSA20-168	1.250	168	2.125	6.000	7.250	1.562	4.125	.625	.375	.562	.281	1/4-20	1/4-20	208.9
TRSA24-168	1.500	168	2.500	6.625	8.125	1.875	4.375	.750	.437	.687	.343	5/16-18	5/16-18	292.8
TRSA32-168	2.000	168	3.250	7.250	9.000	2.250	4.500	.875	.562	.875	.406	3/8-16	3/8-16	437.1
TRSA12-192	0.750	192	1.500	4.500	5.500	1.125	3.250	.500	.312	.375	.221	#10-32	#10-32	107.6
TRSA16-192	1.000	192	1.750	5.250	6.375	1.312	3.750	.562	.312	.500	.281	1/4-20	#10-32	159.7
TRSA20-192	1.250	192	2.125	6.000	7.250	1.562	4.125	.625	.375	.562	.281	1/4-20	1/4-20	238.8
TRSA24-192	1.500	192	2.500	6.625	8.125	1.875	4.375	.750	.437	.687	.343	5/16-18	5/16-18	334.6
TRSA32-192	2.000	192	3.250	7.250	9.000	2.250	4.500	.875	.562	.875	.406	3/8-16	3/8-16	499.6

### Footnotes:

(1) Two threaded leveling holes per TWIN RAIL® support segment are used for setscrew adjustment to aid in assembly leveling to the user mounting surfaces.



Dimensions

(inches)

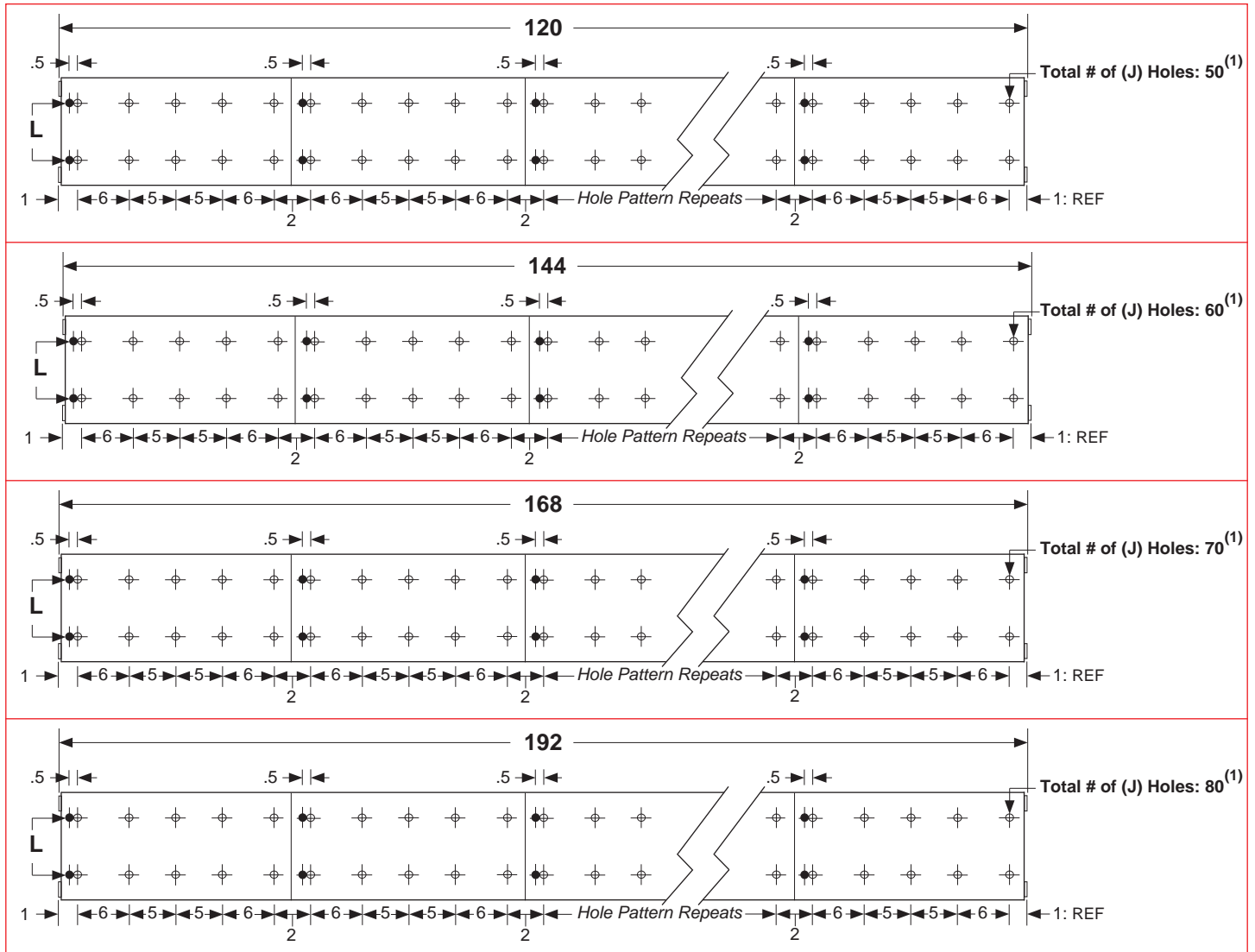
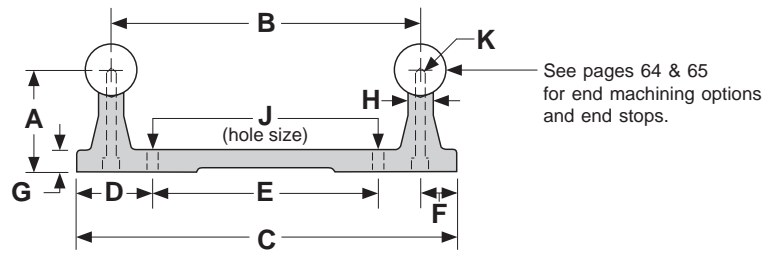

Footnotes:

(1) TWIN RAIL® supports come in 6, 12, 18 and 24 inch segments. The mounting hole location linear tolerance is +/- .010 inches noncumulative per segment. The supports are not one piece for lengths over 24 inches. The mounting hole linear tolerance is +/- .015 inches cumulative from one support segment to the next.

# Options

## Reduced Diameters, End Stops, Coaxial & Radial Holes

Reduced diameters, end stops, coaxial & radial holes can be provided on any shaft or shaft assembly. The standard tolerance for a reduced diameter is  $\pm .001$  inches, while the concentricity is  $.002$  inches TIR. The shaft may be annealed and soft around the shaft circumference adjacent to the reduced diameter. Coaxial holes are drilled and tapped in the center of the shaft ends and radial holes can be drilled and tapped as desired. The concentricity of the holes will be  $.005$  inches TIR.

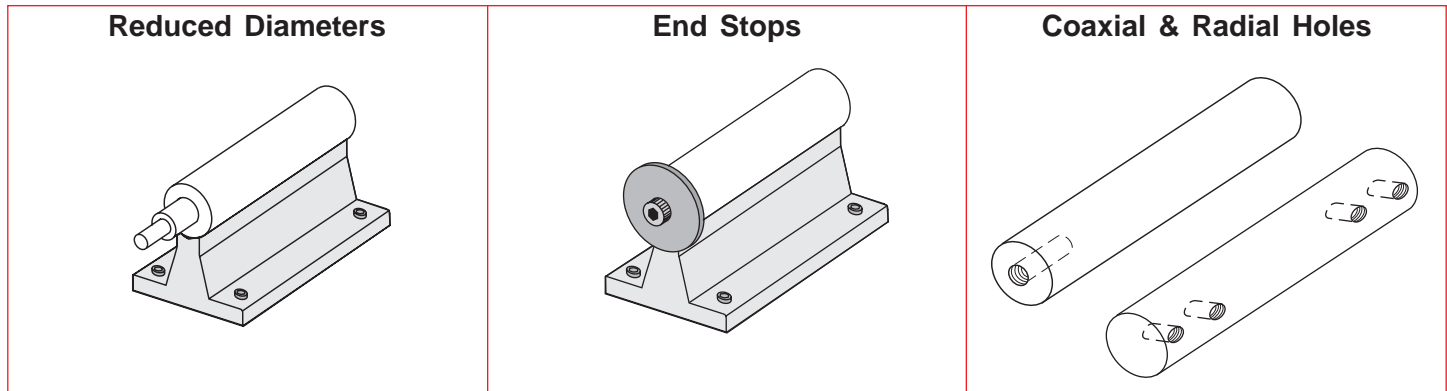

## Butted, Doweled, and Threaded & Ground Joints

Standard shaft assemblies cannot be combined to create longer lengths, as the rolling elements of re-circulating linear bearings will "jam" at the joined ends due to the shaft chamfer. For those long length or custom applications, *LINTECH* provides several options for joining shaft assemblies. Butted, doweled, threaded, and ground joints are available with all shaft lengths and diameters. All of these options will have the standard chamfer removed from the shaft ends. The concentricity of doweled joints is  $< .001$  inches, while the concentricity of butted joints will depend upon the user mounting surface.

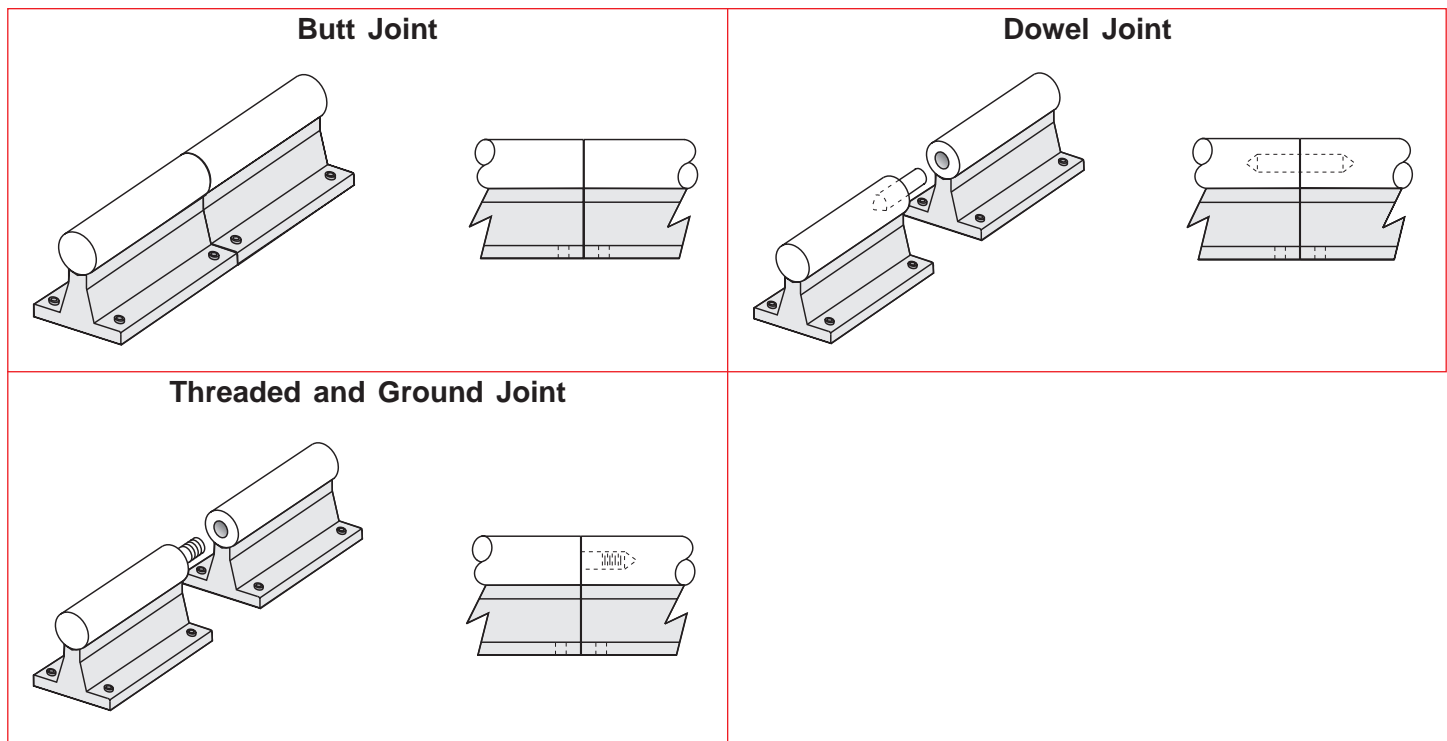

# Options

## Custom Shaft Assembly Lengths & Widths

Custom shaft assembly lengths and widths (shorter and longer) not shown in this catalog can be provided upon request.

## Metric Shaft Assemblies

Metric shaft assemblies can be provided upon request by combining SM shafting with the LSRS or ARS shaft supports.

## Chrome Plated Shafts

For applications in high moisture, high humidity, clean room, or highly corrosive environments, chrome plating of the shafts will offer superior resistance to corrosion. The process uniformly deposits dense, hard, high Chromium alloy onto the shaft, and has a Rockwell C hardness value of 67-72. This process also conforms to MIL Spec: (MIL-C-23422). The chrome plating bonds to the parent steel and will not crack or peel off under the high point loading of the balls on the shaft. This chrome plating process differs from normal hard chrome which just lays on the surface of the part plated.

## Shaft Support Finishes

The standard anodized finish of the aluminum shaft supports can be changed to meet the requirements needed for operation in clean rooms, food processing facilities, highly corrosive environments, or for different appearances. The standard enamel finish of the steel shaft supports can also be changed. Available options are clear or color anodized, chem-film, nickel plated, chrome plated, different oxide color finishes, or painted per customer specifications.

## Shaft Support End Stops

End stops are available for every shaft assembly size and length. They provide a mechanical stop for the linear bearings to prevent them from sliding off the end of the shaft. The shaft ends are drilled, tapped, and a washer is installed using a cap screw and lock washer.

Number of <sup>(2)</sup> End Stops (see model #)	Nominal Shaft Dia. (inches)	Dimensions (inches)			
		A	B	C	D <sup>(1)</sup> Cap Screw
E1, E2, E3, E4	0.500	.375	.062	1.125	1/4
E1, E2, E3, E4	0.625	.453	.062	1.375	5/16
E1, E2, E3, E4	0.750	.532	.062	1.625	3/8
E1, E2, E3, E4	1.000	.656	.109	1.812	7/16
E1, E2, E3, E4	1.250	.750	.125	2.250	1/2
E1, E2, E3, E4	1.500	.750	.125	2.625	1/2
E1, E2, E3, E4	2.000	.750	.125	3.250	1/2

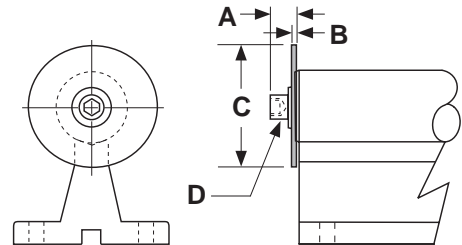

### Footnotes:

- (1) Cap screw for end stops have black oxide finish. End stop & cap screw lock washers are Cadmium plated (QQ-P-416 Type II).
- (2) When only Specifying one end stop (E1) for SA, or two end stops for the TRSA (E2), the end stops will be installed on the left hand end of the assembly, as depicted by the above drawing, unless specified otherwise.