



Positioning Systems



INSTALLATION & SERVICE MANUAL

Welcome to *LINTECH*®



For over 44 years *LINTECH* has designed, engineered, and manufactured mechanical motion solutions for use in a wide range of applications. Whether it is a standard positioning component or a custom positioning system, *LINTECH* takes great pride in manufacturing a quality product.

At *LINTECH* we are proud to provide the motion control user with this general product guide. It was developed to assist you with acquiring the general knowledge of what *LINTECH* has to offer. You can find complete details on all *LINTECH* products via our website.

Depending on the requirements, standard positioning components can often be assembled and shipped in less than 2 weeks. Custom positioning assemblies require a different approach. We evaluate your special application, use our many years of experience to guide you, and then manufacture a quality product designed to meet your performance specifications.

LINTECH's technical support consists of a well trained inside customer service department, an experienced application engineering staff, and a versatile machining facility.

Our local technical support group consists of Automation Specialists located throughout the World. These Automation Specialists are experienced in the use of electronic and mechanical motion control products. They are well trained on the performance capabilities of *LINTECH* positioning components.

LINTECH is constantly designing new products and improving upon the many options available with our standard products. Whether it is a standard or custom positioning system required, visit our website, call, or e-mail us. We look forward to hearing from you.

Visit our website, or call us for the location of the nearest Automation Specialist in your area:

LINTECH®

1845 Enterprise Way
Monrovia, CA. 91016

Toll Free: (800) 435 - 7494

Phone: (626) 358 - 0110

Fax: (626) 303 - 2035

Web Site: www.LintechMotion.com

E-Mail: Lintech@LintechMotion.com



version: 09/2015

	Pages
Introduction	2
<ul style="list-style-type: none">□ Overview	
Warranty & Returns	3
<ul style="list-style-type: none">□ Technical Assistance□ Standard Warranty Policy□ Return Policy□ Dimensions and Product Changes	
Specifications - Linear Positioning Systems	4 - 6
<ul style="list-style-type: none">□ Load Capacity□ Drive Mechanism Types□ Maximum Carriage Speed□ Maximum Carriage Acceleration & Thrust□ Carriage & Table Base Deflection□ Motor Size & Mounting	
Installation - Linear Positioning Tables	6 - 9
<ul style="list-style-type: none">□ Mounting Surface Requirements□ 110 Series Mounting□ Carriage & Table Base Modification□ Environmental Consideration□ Wiring Interface	
Maintenance - Linear Positioning Tables	10 - 14
<ul style="list-style-type: none">□ Lubrication□ Recommended Lubrication Types□ Guidelines for Lubrication□ Lubrication - Standard Tables	
Additional Installation - Linear Positioning Tables - Belt Drives	15 - 17
<ul style="list-style-type: none">□ 120 Series□ 180 Series□ 550 Series	
Options	18 - 27
<ul style="list-style-type: none">□ Motor Couplings□ Linear & Rotary Incremental Encoders□ Power-Off Electric Brakes□ End of Travel (EOT) & Home Switches	
Installation - Rotary Positioning Tables	28 - 29
<ul style="list-style-type: none">□ 300 Series□ 400 Series	
Terms of Sale	31

Overview

Thank you for purchasing a *LINTECH* positioning system. **This manual provides you with important information about your system. It also points out some precautions which should be taken to ensure proper operation, and the longest possible life of your system.** *LINTECH* manufactures both standard and custom positioning systems which are used in a wide variety of applications and industries. The chart below illustrates the different positioning system models available from *LINTECH* and some of their basic features. For a full description and details on your system, please refer to the *LINTECH* Positioning Systems catalog or your original quotation if a custom system was purchased. Every *LINTECH* positioning system will have a "NAME PLATE" attached somewhere to the system, indicating the Model & Serial numbers. If, for any reason, you need to contact *LINTECH*, or an Automation Specialist, please have ready the Model & Serial numbers of your positioning system, as this may speed the process of answering your question.

Table Series	Positioning Type	Bearing Type	Drive Type
90	linear	round rail (shaft)	screw (acme or ball)
100	linear	square (profile) rail	screw (acme or ball)
110	linear	square (profile) rail	screw (acme or ball)
120	linear	square (profile) rail	belt
130	linear	square (profile) rail	screw (acme or ball)
140	linear	square (profile) rail	belt
150	linear	square (profile) rail	screw (acme or ball)
200	linear	square (profile) rail	screw (acme or ball)
250	linear	square (profile) rail	screw (acme or ball)
160	linear	square (profile) rail	screw (acme or ball)
170	linear	square (profile) rail	screw (acme or ball)
180	linear	square (profile) rail	belt
300	rotary	angular contact	worm gear
400	rotary	angular contact	worm gear
550	linear	square (profile) rail	belt
610	linear	square (profile) rail	screw (acme or ball)
Custom Positioning Systems - see individual quotations			

Technical Assistance

Please do not hesitate to call *LINTECH* with any questions you have. You may contact the Automation Specialist in your area for local help, visit our web site or call the factory direct. Either way, your satisfaction is our main concern.

LINTECH

1845 Enterprise Way
Monrovia, CA 91016

Toll Free: (800) 435 - 7494
Phone: (626) 358 - 0110
Fax: (626) 303 - 2035

Web Site: www.LintechMotion.com
E-mail: Lintech@LintechMotion.com

Standard Warranty Policy

All *LINTECH* positioning systems are guaranteed to be free from defects in material and workmanship, under normal use, for a period of one year after date of shipment. This warranty covers the repair or replacement of a product when it is sent prepaid to *LINTECH*. *LINTECH* does not assume liability for installation, abuse, alteration, insufficient application data provided for a design, or misuse of any positioning system. Products furnished by *LINTECH*, but not manufactured by *LINTECH* (motors, gearheads, encoders, amplifiers, etc....), are subject to the manufacturers standard warranty terms and conditions.

Return Policy

Any product requiring a return to *LINTECH* (for warranty or non-warranty repair) requires pre-approval from the factory prior to shipment. Contact the customer service department at (800) 435-7494 in order to obtain a RMA (Return Materials Authorization) number. At that time, please have your system Model & Serial numbers available, along with the reason for the return. The RMA number should be clearly marked on the returned package label and your packing list, or shipping document. Return product freight prepaid in its original package, or one with comparable protection. *LINTECH* will not accept return shipments sent freight collect. Product damage incurred during return shipment, from poor packaging, will not be warranted by *LINTECH*. Keeping original packing materials is recommended until initial inspection & testing is completed.

Dimensions and Product Changes

Published dimensions shown in the Positioning Systems catalogs are known to be accurate at the time of printing. *LINTECH* shall not be held liable, under any circumstances, for any wrongly documented dimension or specification. Changes in design are made whenever *LINTECH* believes its product will improve by the change. No obligation to incorporate these changes in units manufactured prior to a change, will be assumed.

Load Capacity - Dynamic, Static, & Moment Loads

It is very important to know the load capacity of your positioning table. If you purchased a standard catalog item, refer to the Positioning Systems catalog for load capacities. If a custom table was purchased, refer to your quote for the load rating. **WARNING - exceeding the load capacity of your positioning table can result in table damage.** Also, load ratings are based upon the utilization of ALL the carriage mounting holes for securing the load. If you are not sure what the load capacity of your positioning system is, please contact your local Automation Specialist or *LINTECH*.

The dynamic horizontal load rating of a table is the amount of weight centered on the carriage that the table can support while moving. This value is rated for a specific travel life. If this value is exceeded, shorter travel life could result. Depending upon the application, this could mean the lead screw or linear bearings would need to be replaced before the rated travel life of the positioning system is reached.

A static load occurs when a force is applied to the table carriage, with the carriage at zero speed. Typical static forces result from: drilling, grinding, pressing, cutting, welding, or even someone standing on the table. Exceeding the rated static load capacity of a table could result in structural damage to the positioning system.

A Moment load occurs whenever the load center of gravity is not centered on the carriage, or when an external force is applied to the carriage (i.e. side, top, or pushing/pulling thrusts). All vertical, and side mounted applications are considered to be moment loads. See *LINTECH*'s Positioning Systems catalogs for further description on these terms, values for a specific positioning table, load versus life equations, and recommended safety factors.

Proper lubrication of the linear bearing system is required for any positioning table to achieve its expected travel life for a given amount of load capacity.

Drive Mechanism - Screw Types - Acme & Ball

The screw type is another factor influencing the life & performance of a linear positioning system. *LINTECH* uses both acme and ball screws. Acme screws provide smoother low speed operation, and will prevent load backdriving in most vertical applications (no carriage movement when motor power is removed). Ball screws allow for high speed, high duty cycle, longer life, and lower friction operation. Every screw has a load capacity associated with it based on the number of screw revolutions. Refer to the *LINTECH* Positioning Systems catalog for further description and details on screw types, load capacities and life. **WARNING - Exceeding the load capacity of a screw, for a given life (number of screw revolutions), can cause mis-positioning problems, extra system backlash, and a rougher operating positioning system.** Proper lubrication of the nut & screw assembly is required for any positioning table to achieve its expected travel life for a given amount of load capacity.

Some screws are available with preloaded nuts, which eliminates backlash in an application. The preloading of the nut is accomplished several different ways. *LINTECH* DOES NOT recommend that an adjustment of the preload setting be done in the field. The positioning table should be returned to the factory for proper adjustment.

For vertical applications, a power-off electric brake (activates when no power is applied) is recommended for ball screw driven tables due to the high efficiency of the screw. See page 20 of this Service Manual for power-off brake information. The attached load could backdrive (free-fall) the table carriage, if no brake is used. An acme screw is an option available to the user for preventing backdriving of the carriage for most vertical applications.

Drive Mechanism - Belt

The maximum linear forces that a belt driven positioning table can adequately handle are determined by the belt material, belt width, and the number of teeth on the belt pulleys. **WARNING - Exceeding the maximum belt force at a given speed will cause the belt to "skip" over the pulley teeth, thus causing mis-positioning of a table.** Over time, continuous "skipping" of the belt over pulley teeth will weaken the belt, thus lowering the maximum belt force capability and maximum speed. Care should be taken to not exceed the maximum belt force capability. See the individual catalog belt driven positioning table sections for information on belt & pulley force capabilities. Belt tension for a positioning table is set at the factory and under normal use does not need to be adjusted.

Maximum Carriage Speed

The maximum speed of a positioning table will either depend on the components of the bearing system or the drive mechanism assembly. Table damage could occur if the carriage speed exceeds the rated velocity value of a positioning system (**exceeding this value once could cause damage**).

For screw driven tables, types of damage include misalignment (bending) of the screw, binding in the screw, radial bearings pulled from end plates, and rough/audibly loud performance. The maximum speed of the carriage is determined by the screw lead, screw length, screw diameter, and bearing support system.

For belt driven tables damage can occur to the belt & pulley assembly and the linear bearings. The maximum speed of the carriage is either determined by the maximum force the belt & pulley assembly can handle or the maximum speed of the linear bearing system. The maximum linear force that a belt & pulley can adequately handle is determined by the belt material, belt width, and the number of teeth on the belt pulleys. **WARNING - Exceeding the maximum belt force at a given speed will cause the belt to "skip" over the pulley teeth, thus causing mis-positioning of a table.** Over time, continuous "skipping" of the belt over pulley teeth will weaken the belt, thus lowering the maximum belt force capability and maximum speed.

The maximum safe operating speed of a standard positioning table is shown in the Positioning Systems catalogs. Custom positioning tables will have the maximum safe operating speed indicated on the original quotation, or on the motor sizing printout. **WARNING - Maximum carriage speed must be limited by the position controller! Exceeding the maximum carriage speed voids the warranty on any *LINTECH* table.**

Maximum Acceleration Rate & Thrust Forces

As a positioning table starts motion with a given acceleration rate, a thrust force is generated ($F=MA$). This thrust force creates extra stresses on several components within a positioning table. Too high an acceleration rate, even with a light load, can cause damage to either a screw, or belt, driven positioning table's components. Refer to the Positioning Systems catalog specification section for the maximum acceleration rate and thrust force capacity for a particular table model number. **WARNING - Exceeding these ratings can cause damage to the positioning table components and should be avoided.**

Carriage Deflection

Carriage deflection (or table rigidity) is the amount of movement the carriage experiences when the attached load is acting as a moment load. If a three dimensional deflection value is important for your application, your specification should have been supplied to *LINTECH* prior to ordering, since it may require a special table construction. Deflection values are not specified for any standard positioning table since they are affected by individual table construction, linear bearings, customer load mounting orientation, customer mounting surface, load weight, and how the load is applied.

Table Base Deflection

The positioning table's I value (moment of inertia), the load, and the mounting configuration are main factors contributing to the deflection a table structure experiences for a given application. If a positioning table is fully supported over its entire length, and the proper safety factors for the linear bearing & drive mechanism are used, all standard *LINTECH* positioning tables will function properly. If a positioning table is mounted to a surface where the base is not fully supported, the table will experience a degree of deflection. If the deflection is too extreme, a positioning table will not function properly (usually binding occurs), and could fail outright. Increase of input torque required to move a load is usually the symptom encountered in applications with too much deflection. Refer to the Positioning Systems catalog for load capacities, I values, and safety margins.

Motor Size and Mounting

LINTECH positioning systems can be driven by any step motor or servo motor system. NEMA 23, 34, or 42 motor mounts are provided as standards. In most cases any non-NEMA motor can be mounted to any *LINTECH* positioning system with the addition of an optional motor adapter bracket. If ordered from *LINTECH*, this optional motor adapter bracket will be pre-mounted to the positioning table. If a user supplied motor adapter bracket is being installed to a positioning table, care should be given to the thickness of the motor adapter bracket. Too thick of an adapter bracket, along with a potentially short non-NEMA standard motor shaft, can cause the supplied motor coupling to be too short to "properly couple the motor shaft to the screw (or belt) shaft extension. If such a situation arises, a different motor coupling with a longer length may be required. See the motor coupling section on pages 16 & 17 of this Service Manual for more details.

The proper way to mount any motor to a *LINTECH* positioning system is to FIRST securely mount the motor to the adapter bracket, and then firmly tighten the set screw clamp on the motor coupling. Also, check the tightness of the coupling to the lead screw (or belt) shaft extension. Some mis-positioning problems associated with positioning tables is due to "LOOSE" coupling connections.

NEVER oversize a motor/control system for a particular table. Installing a motor with has a large torque output, to a positioning system that CANNOT handle the full capacity of the attached motor, can cause positioning system damage. Also, larger size motors (length & weight) can cause excessive vibrations to a positioning system. These vibrations can lead to early fatiquing of positioning system components in high accel/decel applications.

Mounting Surface Requirements

In order to achieve the published accuracy & repeatability of a *LINTECH* positioning table, care must be taken when mounting the table to your surface. The mounting surface for the positioning table must be as flat, or flatter, than the positioning table itself. If the surface is not, "shimming" may be required. Refer to the *LINTECH* Positioning Systems catalog for standard flatness & straightness specifications for each tables series. Proper table mounting is essential if the application calls for published *LINTECH* specifications to exist. It is also highly recommended that the table be supported over its entire length and that all table base mounting holes are used. This will prevent the table from deflecting over unsupported regions when the load travels over that area. It also maintains the system rigidity, and prevents shortened positioning table life from structural fatigue.

110 Series Mounting

Enclosed with the 110 series Positioning Table packaging is a pair of stainless steel retainer strips that are equal in length to the table base length. These strips are used to prevent the waycovers from falling away from the table in vertical, inverted, or side mounted applications. They also aid to minimize the "open" gap between the outside edge of the waycovers, and the table. Thus, the strips may be important to be a deterrent to certain particulates entering the inside of the 110 series table cavity in some applications. The retainer strips attach to the table via the base mounting screws. For factory configured X-Y systems, the retainer strips will be pre-installed on the Y (top) axis with a set of strips only provided for the X (bottom) axis.

Installation consists of removing the waycover retainer screws on both sides of the carriage plate. Slide the covers to their fully retracted (collapsed) position and then slide the retainer strips over the base mounting holes prior to mounting the 110 series table to your base structure. The retainer strip holes directly "lineup" with the base mounting holes. See below.

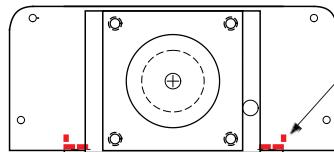

Note: A pair of stainless steel retainer strips are furnished with each 110 series table. These strips are used to prevent the waycovers from falling away from the table in vertical, inverted or side mounted applications and must be installed by the user mounting surface. The retainer strips attach to the table via the base mounting screws.

Carriage & Table Base Modification

LINTECH DOES NOT recommend that any positioning system (standard or custom) be disassembled by the user. **WARNING - Dismantling any LINTECH positioning system, without the consent of LINTECH will void the warranty on the system.** LINTECH takes special care in manufacturing and assembling of every positioning system. Special tools, assembly surfaces, and certain procedures are adhered to during the assembly of each system. It is therefore extremely important that NO positioning system be "taken apart" for any reason, if the published performance specifications and table life are required for your application. Each positioning system has either threaded stainless steel inserts in the carriage, or a T-slot, for mounting the user supplied load. A load adapter plate should be used between the load and the carriage surface if your load cannot use the supplied LINTECH threaded inserts. Also, LINTECH supplies base mounting holes for securing the positioning system to the user supplied mounting surface. For exact location and size of carriage and base mounting holes please refer to the LINTECH Positioning Systems catalog or the CAD generated drawing of your custom system.

Positioning Table Series	Carriage Inserts ⁽¹⁾ English mount (Metric mount)	Recommended Base Mounting Screws ⁽²⁾ English mount (Metric mount)	Motor Mount Bracket ⁽¹⁾ English mount (Metric mount)
90	1/4-20 x .500 deep (M6 thd. x 12,7 deep)	#10-24 (M5 thd.)	#10-24 (M5 thd.)
100, 110, 120, 130 and 140	#8-32 x .250 deep (M4 thd. x 8,0 deep)	#8-32 (M4 thd.)	#10-24 (M5 thd.)
150	1/4-28 x .500 deep (M6 thd. x 12,7 deep)	1/4-28 (M6 thd.)	#10-24 (M5 thd.)
160	Separate Fastening Rail with M5 thd.	#10-32 (M5 thd.)	#10-24 (M5 thd.)
170 and 180	1/4-20 x .500 deep (M8 thd. x 12,0 deep)	#10-32 (M5 thd.)	#10-24 (M5 thd.)
200	5/16-24 x .500 deep (M8 thd. x 12,7 deep)	5/16-24 (M6 thd.)	#10-24 (M5 thd.)
250	3/8-24 x .500 deep (M10 thd. x 12,7 deep)	3/8-24 (M8 thd.)	#10-24 (M5 thd.)
550	Separate Fastening Rail with M5 thd.	Base Mounting Bracket	#10-24 (M5 thd.)
610	1/4-20 x .500 deep (M6 thd. x 10,0 deep)	Base Mounting Bracket or Optional Tapped Base Holes 1/4-20 (M6 x 1.0)	#10-24 (M5 thd.)

Footnotes:

- (1) Carriage Inserts and the Motor Mount Bracket come as either an English mount or a Metric mount - not both.
 (2) Base Mounting screws are NOT provided by LINTECH.

Environmental Considerations

The life of your positioning table is highly dependent upon its operating environment. Premature failure can occur if the system is not designed to operate within the environmental conditions where it is installed. Some environments which warrant special considerations are as follows:

- 1) High moisture, humidity, condensation, outdoors, fluid splashing, or corrosive.
- 2) Grinding, welding, etc. - where debris can contaminate screw nut & bearings.
- 3) High or low ambient operating temperatures.
- 4) Speciality environments such as - clean rooms, vacuums, underwater, radioactive, or "gritty" particles in atmosphere (glass, ceramic, etc.).

The positioning table design may need to change depending upon the type of environmental condition it is being used in. Below is a list of recommended table options to withstand various environments.

<i>Environment</i>	<i>Positioning table design should include:</i>
* Corrosive	: Chrome plated or stainless steel rails, screw, and bearings. All mounting hardware should also be stainless material.
* Dusty	: Waycovers should be used to prevent buildup of debris on rails & screw. This would apply to grinding/drilling, welding, and cutting type applications.
* Gritty Particles	: Waycovers with positive air pressure under waycovers, or external particulate dust collection system (vacuum).
* Welding	: May require high temperature waycovers to protect from hot weld spatter.
* High/low Temp	: Special lubricants and table materials.
* Vacuum	: Special lubricants and table materials.
* Clean Room	: Chrome Plated rails, screw, and bearings. Low out gassing grease & plastics.

In applications where there is an extreme amount of particulate generation, positive air pressure should be considered on the table in conjunction with the waycovers. As waycovers compress, an inward airflow can be created that can be strong enough to "suck" particulates into the Positioning Table drive cavity. The speed at which the table moves directly affects the magnitude of the inward airflow intensity.

Wiring Interface

Precautions should be taken when interfacing encoders, or EOT & HOME switch cabling to your position control. Since these cables operate on low voltage levels (typically +5 to 24 VDC), they should be routed separately from higher motor voltage wiring (90 VDC switching, 120 to 460 VAC, etc.). High voltage cables generate higher magnetic fields around their cable, which can induce current flow into low voltage wiring, if placed in close proximity to each other. This induced current could be sufficient enough to provide "**false signals**" to your position controller of encoder, or EOT & Home signals. Always route switch & encoder cables separately from other higher voltage cables. Also, you may need an adjustable power supply when interfacing longer low voltage cables to your position control. This ensures that you will have the proper operating voltage levels at the encoder & switches, as there may be voltage drops on the cables over a long distance.

Electrical noise is another concern when interfacing to a position control system. Electrical noise can cause problems with any controller resulting in unpredictable performance or even failure of the position controller. It is recommended that precautions be taken to minimize electrical noise from becoming a problem in system interface design. This can be achieved with proper shielding and grounding. All *LINTECH* supplied cables are shielded. The shield for the mechanical switches without power supplied to them, should be connected to a low impedance earth ground point at the position control. Cabling for switches and encoders requiring a power supply, should have the shield connected to the power supply ground. The quality of ground from one company facility to another can be different. Thus, it could be possible that other wiring precautions may be required for proper noise free operation. It is important to consult with your position control manufacturer prior to installation for their interface recommendations & precautions. If unpredictable performance occurs, contact your position control manufacturer first with description of malfunction. If further assistance is needed, contact our application engineering department for assistance. Please have wiring diagrams, system components list, environment data, and details on the problem area prior to calling us, or the position control manufacturer for assistance. ***LINTECH* is not responsible for problems caused with the positioning system from improper wiring or electrical noise.**

Lubrication

Every *LINTECH* positioning table requires grease or oil for proper, long-term operation. Lubrication will dissipate heat, reduce friction, decrease system wear, and aids in preventing oxidation (rust) to those positioning table components that require protection. For most applications, a medium to heavy oil, light grease, or Synthetic Teflon based lubricant is recommended. The frequency of lubrication will ultimately be determined by the system application and table environment. Lack of lubrication could prevent a positioning table from reaching its normal expected life.

The many built-in pockets within the **linear bearings** that *LINTECH* uses, will allow the adhesive properties of most lubricants to be stored, and used by the recirculating balls for extended periods of time. Thus, as the positioning table moves back & forth, lubrication is applied to the linear rails. Most of the linear bearings have a lube port located on the bearing block (or carriage assembly) which allows for easy access to add lubricants.

Because **acme screw & turcite nut** screw driven positioning tables have a solid surface contacting a solid surface, sufficient lubrication becomes a must. If there is not proper lubrication, the higher frictional forces of these nuts will cause excess wear to the assembly, thus preventing required positioning table life from occurring. Applying lubrication directly onto the entire length of the screw on a regular basis is highly recommended.

For **ball screw** driven positioning tables, the many built-in pockets within the nut assembly will allow the adhesive properties of most lubricants to be stored, and used by the recirculating balls for extended periods of time. Thus, as the positioning table moves back & forth, lubrication is applied to the ball screw. The nut assembly will pick up grease, or oil that is spread over the entire length of the screw. Therefore, applying lubrication directly onto the entire length of the screw on a regular basis is recommended.

All standard *LINTECH* positioning tables include radial/thrust bearings which are sealed, and require no lubrication. Custom positioning systems rated for vacuum, or high temperature operation, may not necessarily use sealed bearings. Therefore, lubrication with a vacuum rated or high temperature grease may be required.

Insufficient lubrication can result in excessive wear which may cause scoring of the rails, ball screw failure, rough table operation, corrosion, and even total failure of the positioning system. Depending upon the application, this could eventually require screw, linear bearing, and linear rail replacement. All *LINTECH* standard positioning systems are shipped with either a High Grade (MIL spec - Castrolase AI - Mil-G-23827B) grease, or 68 weight oil prior to shipping. This lubrication is done to help prevent corrosion during shipping of the product. Lubrication of all mechanical moving linear components is required during the installation process, **prior to operation**. Frequency of re-lubrication must be determined for each individual installation based upon the applied load, move profiles, duty cycle, and environment. There is no easy set of rules, or equation, to help calculate the frequency of re-lubrication, so it should be done imperically.

Recommended Lubrication Types

The type of lubrication may vary depending upon the application, speed, and environment in which the positioning system is installed into. When we talk about lubrication we are referring to the linear bearings, linear rails, and screw assembly. The recommended lubrication types include: High Grade Bearing Grease, Light Weight Oil (50 weight or higher), 80/90 Weight Gear Oil, or a Synthetic Teflon based compound. These type of lubricants should be available through your local lubricant supplier, or hardware/automotive supply store. Use of WD-40, or other cleaning solvents, **should strictly be avoided**, as they can cause damage to the screw assembly, linear bearings, and linear rails.

Guidelines for Lubrication

There is no specific equation *LINTECH* can provide for lubrication. We can only provide guidelines based upon numerous positioning system installations. Ultimately, the frequency of lubrication is determined by your personal preference and the positioning table application. Some applications will require a high frequency of lubrication. These include but are not limited to: high linear speeds, heavy loads, extreme smoothness, high accelerations, high duty cycles, applications which require friction free motion, or high frequency oscillating moves.

High speed applications can use grease or oil type lubrication. The screw assembly & linear bearings should NEVER be operated dry for any length of time. Grease is the preferred type since the grease stays on the ball screw & linear rails for a longer period of time than oil lubricants. Oil type lubricants can also cause oil "splattering" to surrounding equipment. However, an automatic oil lubrication system may be required for some 24 hours per day, 7 days per week continuous operating applications.

Proper positioning table maintenance would entail lubricating the screw assembly (acme or ball), linear rails, and the linear bearings. Since an acme screw generates a larger amount of friction due to its construction, it may require more frequent lubrication versus ball screws depending upon the application. Most linear bearings will have either a lubrication fitting or lube hole for inputting the grease or oil. Lubricate directly onto the screw assembly and linear rails over their entire length for maximum results. This same process should be followed whenever a regular maintenance routine is scheduled.

Lubrication - Standard Tables

Recommended Lubrication:

Use high grade bearing grease (*LINTECH* uses - Castrollease AI G-354 * Mil-G-23827B), or higher than 50 weight oil (*LINTECH* uses 68 weight oil).

90 Series (round rail) Screw Drive:

Apply grease, or oil, over the entire length of the screw assembly and linear rails. Also apply grease, or oil, to each linear bearing via the lubrication access hole. No lubrication required for the lead screw radial/thrust bearings. For waycover options: lift up the waycovers to apply lubrication to the screw assembly and linear rails.

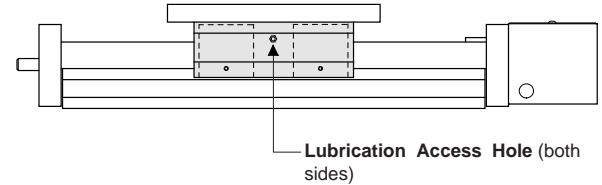

90 series has a 1/4"-28 access for lubrication.

150, 200 & 250 Series (square rail) Screw Drive:

Apply grease, or oil, over the entire length of the screw assembly and linear rails. Also apply grease, or oil, to each linear bearing via the lube fitting. No lubrication required for the lead screw radial/thrust bearings. For waycover options: lift up the waycovers to apply lubrication to the screw assembly and linear rails.

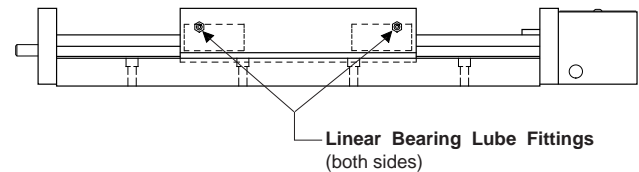

100, 110 & 130 Series (square rail) Screw Drive:

Apply grease, or oil, over the entire length of the screw assembly and linear rails (each edge of each rail). Each individual bearing will pickup grease as motion occurs back & forth. No lubrication required for the screw assembly radial/thrust bearings. For waycover options: lift up the waycovers to apply lubrication to the screw assembly and linear rails.

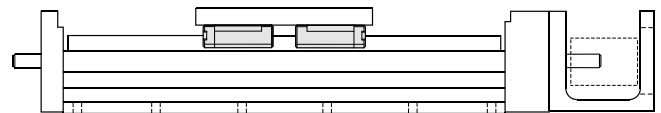

Lubrication - Standard Tables

Recommended Lubrication:

Use high grade bearing grease (*LINTECH* uses - Castrollease AI G-354 * Mil-G-23827B), or higher than 50 weight oil (*LINTECH* uses 68 weight oil).

120 & 140 Series (square rail) Belt Drive:

Apply grease, or oil, over the entire length of the linear rails. The drive pulley (at motor mount end), and the return pulley, have sealed bearings. Thus, they DO NOT require any lubrication.

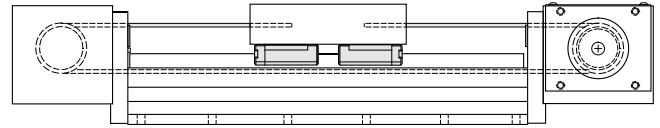

160 & 170 Series (square rail) Screw Drive:

Apply grease, or oil, over the entire length of the screw assembly and linear rails. Also, if possible, apply grease, or oil, to each linear bearing via the lube fitting (see note below). No lubrication required for the lead screw radial/thrust support bearings. For waycover options: lift up the waycovers, or pull back from end plates, to apply lubrication to the screw assembly and linear rails.

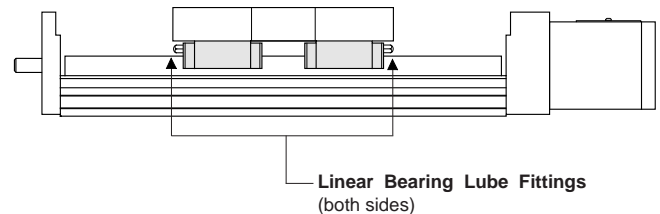

Note: The lube fitting on the bearings requires a special adapter for ordinary lube guns. Contact LinTech for purchasing this special adapter.

180 Series (square rail) Belt Drive:

Apply grease, or oil, over the entire length of the linear rails. Also, if possible, apply grease, or oil, to each linear bearing via the lube fitting (see note below). The drive pulley (at motor mount end), and the return pulley, have sealed bearings. Thus, they DO NOT require any lubrication.

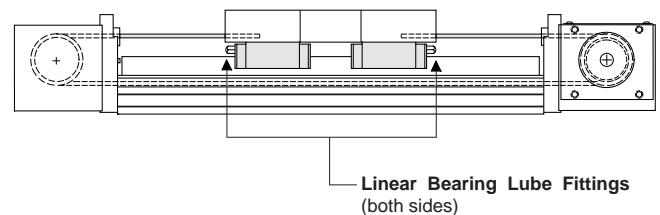

Note: The lube fitting on the bearings requires a special adapter for ordinary lube guns. Contact LinTech for purchasing this special adapter.

Lubrication - Standard Tables

Recommended Lubrication:

Use high grade bearing grease (*LINTECH* uses - Castrollease AI G-354 * Mil-G-23827B), or higher than 50 weight oil (*LINTECH* uses 68 weight oil).

550 Series (square rail) Belt Drive:

Apply grease to the linear bearings by using one of the four lube ports located on the carriage. All 4 of the lube ports are interconnected, therefore applying grease to just one of the lube ports is required. The drive pulley (at motor mount end), and the return pulley, have sealed bearings. Thus, they DO NOT require any lubrication.

Standard Flush Type Coupler
LINTECH part # 45221

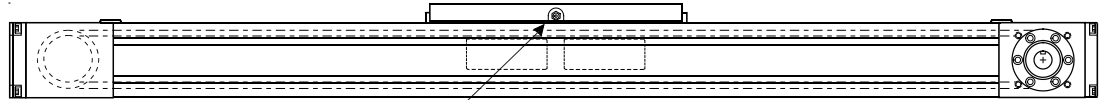
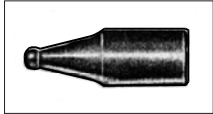

Linear Bearing Lube Fittings
(both sides & 2 fittings on top are all interconnected)
(only one has to be used)
(Use standard Flushtype coupler - 1/8" Threaded NPTF)

610 Series (square rail) Screw Drive:

Apply grease to the screw nut assembly by using one of the 2 lube ports that are located on either side of the carriage. Both of the lube ports are interconnected, therefore applying grease to just one of the lube ports is required. The linear bearing system has a lubrication storage pad that provides long periods of operation before lubrication is required. If lubrication of the linear bearing system is required some disassembly of the carriage needs to be performed. No lubrication is required for the lead screw radial/thrust support bearings.

Standard Flush Type Coupler
LINTECH part # 45221

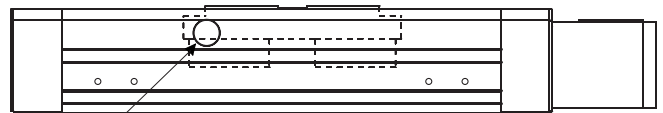
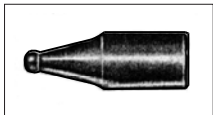

Screw nut lube fitting access (both sides) use LinTech 45221 adapter for "grease gun"
1/8"

120 & 140 Series Belt Drive Positioning Table

LINTECH's 120 or 140 series positioning table uses a belt & pulley drive system instead of a screw & nut system. This provides the user with a few different installation and maintenance considerations. Lubrication of the linear rails should follow the recommendations on pages 10-12 of this service manual. The polyurethane belt with reinforced high strength steel members is adjusted by *LINTECH* for proper tension prior to shipment. Under normal and proper use, the belt tension need not be adjusted. However, if field adjustment is required because of belt stretching, the self-locking belt tension adjustment screw shown below, quickly modifies belt tension with just a partial turn. **WARNING** - putting "too much" tension on the belt can cause permanent stretching and tearing of the belt. Therefore be careful when adjusting belt tension. A general rule of thumb is that when you press down on the top belt - there should be some deflection - **DO NOT try to eliminate all the deflection.** **WARNING** - *LINTECH* is not responsible for improper field adjustments of belt tension.

Another installation item to be concerned about is the maximum input torque to the 120 or 140 series positioning table drive shaft. The maximum input torque to any belt drive positioning table is limited by the belt & pulley system and is speed dependent. **WARNING** - Exceeding any of these values, by either a directly coupled motor or from the output of a gearhead & motor system, can deform or shear a belt tooth, and/or cause the belt to slip over pulley teeth during motion. Refer to the Positioning Systems catalog for maximum input torque to the 120 or 140 series table.

120 & 140 Series Belt Tension Adjustment:

Important Note: Only a partial turn of the self-locking screw is required for increasing, or decreasing, the tension on the belt. **DO NOT** try to eliminate all belt deflection.

Step 1: Remove the attached motor/gearhead from the table and take a Breakaway torque reading with a torque wrench. If the reading is between 45 to 60 oz-in : **NO** adjustment is required. Otherwise, locate the Belt Tension Screw.

Step 2: Take breakaway torque readings with the torque wrench after each 1/4 clockwise turn of the Belt Tension Screw. Stop turning the Belt Tension Screw once the breakaway torque reading is between 45 to 60 oz-in. The belt tension is now adjusted correctly for proper table operation. **DO NOT** exceed 100 oz-in of breakaway torque.

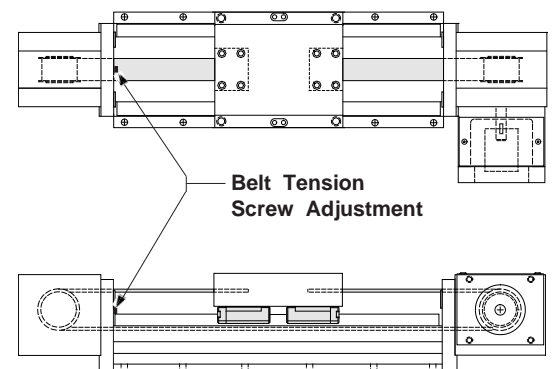

120 & 140 Series Gearheads:

The gearhead, with correct coupling, will be pre-mounted to the 120 or 140 series table if the gearhead was purchased from *LINTECH*. *LINTECH* offers 2 different versions of gearheads.

Version 1 has 4 nut & bolt sets, and an easy to mount motor clamp-on pinion. The included gearhead drawing shows the exact mounting location on the motor shaft for the clamp-on pinion. **WARNING** - This location is critical for proper operation & life of the gearhead - care should be taken when mounting the motor to the gearhead.

Version 2 has an integral coupling for the motor shaft. Four nut & bolt sets are provided to mount the motor.

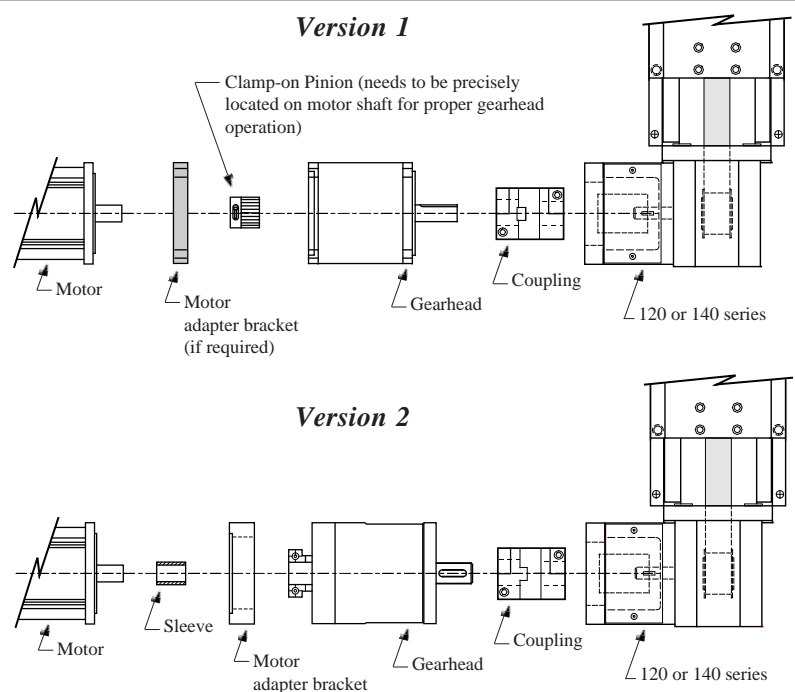

180 Series Belt Drive Positioning Table

LINTECH's 180 series positioning table uses a belt & pulley drive system instead of a screw & nut system. This provides the user with a few different installation and maintenance considerations. Lubrication of the linear rails should follow the recommendations on pages 10-12 of this service manual. The polyurethane belt with reinforced high strength steel members is adjusted by *LINTECH* for proper tension prior to shipment. Under normal and proper use, the belt tension need not be adjusted. However, if field adjustment is required because of belt stretching, the self-locking belt tension adjustment screw shown below, quickly modifies belt tension with just a partial turn. **WARNING** - putting "too much" tension on the belt can cause permanent stretching and tearing of the belt. Therefore be careful when adjusting belt tension. A general rule of thumb is that when you press down on the top belt - there should be some deflection - **DO NOT try to eliminate all the deflection.** **WARNING** - *LINTECH* is not responsible for improper field adjustments of belt tension.

Another installation item to be concerned about is the maximum input torque to the 180 series positioning table drive shaft. The maximum input torque to any belt drive positioning table is limited by the belt & pulley system and is speed dependent. **WARNING** - Exceeding any of these values, by either a directly coupled motor or from the output of a gearhead & motor system, can deform or shear a belt tooth, and/or cause the belt to slip over pulley teeth during motion. Refer to the Positioning Systems catalog for maximum input torque to the 180 series table.

180 Series Belt Tension Adjustment:

Important Note: Only a partial turn of the self-locking screw is required for increasing, or decreasing, the tension on the belt. **DO NOT** try to eliminate all belt deflection.

Step 1: Remove the attached motor/gearhead from the table and take a Breakaway torque reading with a torque wrench. If the reading is between 45 to 60 oz-in : **NO** adjustment is required. Otherwise, locate the Belt Tension Screw.

Step 2: Take breakaway torque readings with the torque wrench after each 1/4 clockwise turn of the Belt Tension Screw. Stop turning the Belt Tension Screw once the break-away torque reading is between 45 to 60 oz-in. The belt tension is now adjusted correctly for proper table operation. **DO NOT** exceed 100 oz-in of breakaway torque.

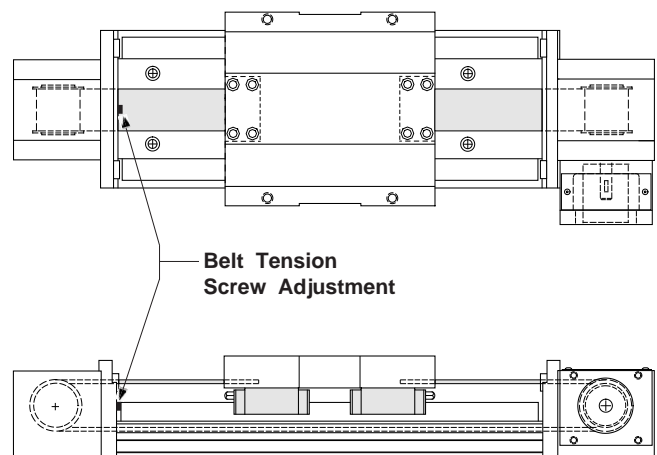

180 Series Gearheads:

The gearhead, with correct coupling, will be pre-mounted to the 180 series table if the gearhead was purchased from *LINTECH*. The gearhead has an integral coupling for the motor shaft. Four nut & bolt sets are provided to mount the motor.

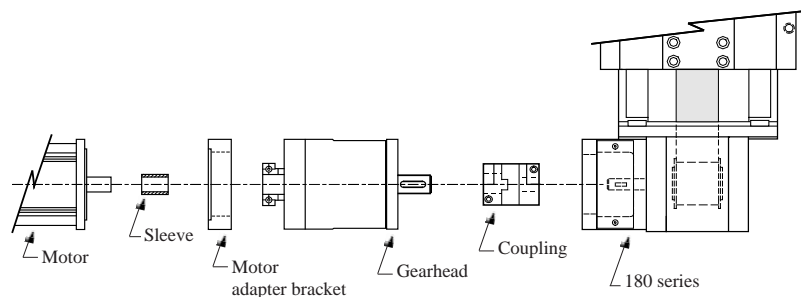

550 Series Belt Drive Positioning Table

LINTECH's 550 series positioning table uses a belt & pulley drive system instead of a screw & nut system. This provides the user with a few different installation and maintenance considerations. Lubrication of the linear rails should follow the recommendations on pages 10-12 of this service manual. The polyurethane belt with reinforced high strength steel members is adjusted by LINTECH for proper tension prior to shipment. Under normal and proper use, the belt tension need not be adjusted. However, if field adjustment is required because of belt stretching, the self-locking belt tension adjustment screws shown below, quickly modify belt tension with just a partial turn of each. **WARNING** - putting "too much" tension on the belt can cause permanent stretching and tearing of the belt. Therefore be careful when adjusting belt tension. **WARNING - LINTECH is not responsible for improper field adjustments of belt tension.**

Another installation item to be concerned about is the maximum input torque to the 550 series positioning table drive shaft. The maximum input torque to any belt drive positioning table is limited by the belt & pulley system and is speed dependent. **WARNING - Exceeding any of these values, by either a directly coupled motor or from the output of a gearhead & motor system, can deform or shear a belt tooth, and/or cause the belt to slip over pulley teeth during motion.** Refer to the Positioning Systems catalog for maximum input torque to the 550 series table.

550 Series Belt Tension Adjustment:

Important Note: The 4 Set Screws lock into place 2 Belt Tension Screws. The 4 Set Screws must first be loosened before the 2 Belt Tension Screws can be adjusted. Only a partial turn of the 2 Belt Tension Screws is required for increasing, or decreasing, the tension on the belt. **DO NOT** over tension the belt.

Step 1: Remove the attached motor/gearhead from the table and take a Breakaway torque reading with a torque wrench. If the reading is close to 16 in-lbs : **NO** adjustment is required. Otherwise, locate the Belt Tension Screws by removing the "Window Cover Plate (held in place with 4 screws)" which is located on the 550 table end opposite the motor mount.

Step 2: Loosen the 4 set screws that lock the 2 Belt Tension Screws in place. Take Breakaway torque readings with the torque wrench after each 1/2 clockwise turn of both Belt Tension Screws. Stop turning the Belt Tension Screws once the Breakaway torque reading is between 12 to 16 in-lbs. **DO NOT** exceed 25 in-lbs of Breakaway torque.

Step 3: Once the desired Breakaway torque is reached, manually move the table carriage to the motor mount end and observe through the "Belt Tracking Window" how the belt tracks against the belt return pulley. Then manually move the table carriage to the opposite end of travel and observe how the belt tracks against the belt return pulley. The belt will move side to side on the belt return pulley - but the belt should never run up on the sides of the belt return pulley. Small, 1/8 turns of either "Belt Tension Screw" may need to be made to keep the belt centered on the belt return pulley. The belt tension is now adjusted correctly for proper table operation.

Step 4: Tighten the 4 set screws that lock the 2 Belt Tension Screws in place, remount the "Window Cover Plate", and fill the 4 counter bored holes that hold the "Window Cover Plate" in place with RTV or equivalent.

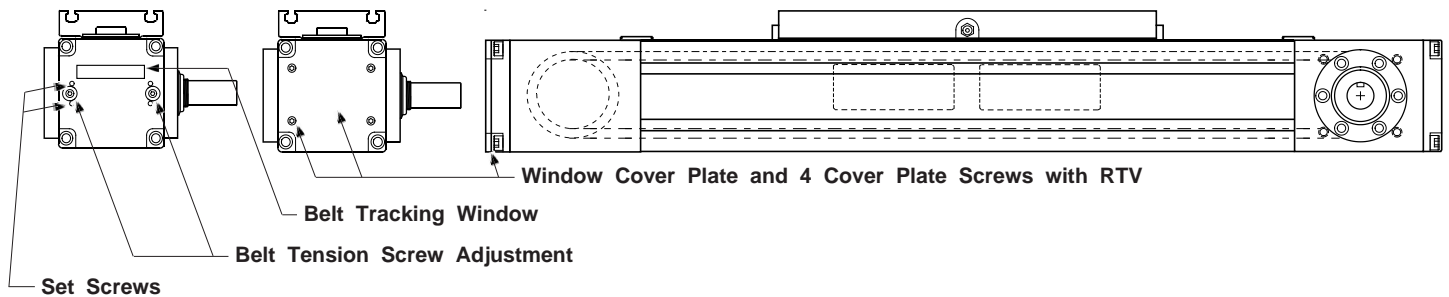

550 Series Gearheads:

The gearhead, with correct coupling, will be pre-mounted to the 550 series table if the gearhead was purchased from LINTECH. The gearhead has an integral coupling for the motor shaft. Four nut & bolt sets are provided to mount the motor.

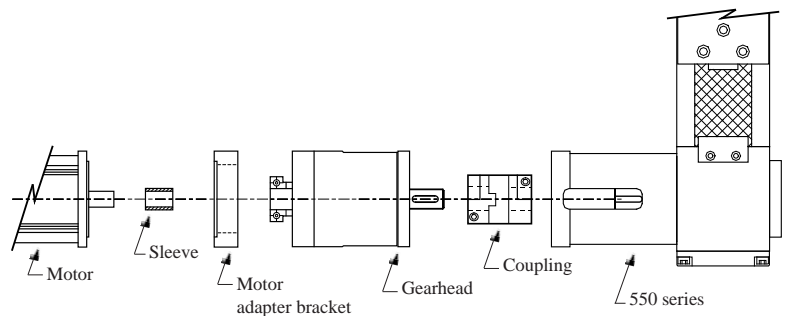

Motor Couplings

LINTECH provides three different types of couplings that can be used to mount a motor to a positioning table. These couplings compensate for misalignment between the motor shaft & screw (or belt) drive shaft extension. This provides for trouble-free operation as long as certain precautions are taken. The connected motor output torque should never exceed the coupling maximum torque capacity.

These couplings are not limited by speed, but can be damaged if a move profile has large acceleration rates or is constantly "SLAMMED" into a mechanical hard stop. Large inertia loads with quick acceleration and deceleration rates could also have the damaging effects to a coupling by weakening it over time. Couplings with larger torque capacity may be required for high accelerations, large back driving vertical loads, high torque output motors or gear boxes, etc..

One common cause for coupling failure is from the user not connecting the EOT switches to a position controller. This situation can result in the carriage over traveling the EOT switches to the point where the carriage collides with the positioning table end plates. The sudden mechanical stop between the carriage & the end plates fatigues the coupling, which can cause coupling failure. This also can destroy mechanical end of travel switches, and the lead screw nut, or belt & pulley, assembly. Therefore, it is not a good practice to use any positioning table's end plates as a mechanical hard stop.

Another cause of coupling failure can occur during the tuning of a servo system that is attached to the positioning table. When servo gains are first adjusted, violent oscillations can occur, which can fatigue, or damage, a coupling. Care should be taken to limit these wild oscillations, by either tuning the servo system before coupling the motor to the table, or by limiting the current in the servo drive during the tuning process.

Motor Adapter Brackets - Another important area of coupling concern is in cases where a non- LINTECH motor adapter bracket is being installed by the user to a positioning table. In some cases, the added bracket thickness along with a potentially short motor shaft extension, can cause the LINTECH supplied coupling to be too short to "clamp" onto the motor shaft. If such a situation arises, a different coupling with a longer length may be required. See page 17 for a list of standard LINTECH couplings. Custom couplings will require factory contact to determine torque capacity. Coupling Maximum Torque values shown on the next page define the input torque at which the coupling can immediately fail. It is "good practice" to select a coupling which has at least 2x (two times) the safety margin above the PEAK coupling input torque. Example: 15 N-m of peak output torque from a motor/gearhead should utilize a coupling which has a Maximum Torque value of at least 30 N-m.

Positioning Table Series	Shaft extension diameter at motor mount end inches (mm)	Maximum Allowable Coupling Dimensions for use with					
		NEMA 23 Motor Bracket		NEMA 34 Motor Bracket		NEMA 42 Motor Bracket	
		Diameter	Length	Diameter	Length	Diameter	Length
		inches (mm)	inches (mm)	inches (mm)	inches (mm)	inches (mm)	inches (mm)
90 and 150	.375 (9,53)	1.500 (38,10)	2.100 (53,34)	1.500 (38,10)	2.600 (66,04)	N.A.	N.A.
100, 110 and 130	.312 (7,92)	1.500 (38,10)	1.750 (44,45)	1.500 (38,10)	2.250 (57,15)	N.A.	N.A.
120, 140 and 180	.375 (9,53)	1.500 (38,10)	1.900 (48,26)	2.000 (50,80)	2.375 (60,32)	N.A.	N.A.
160, 170 and 610	.375 (9,53)	1.500 (38,10)	1.750 (44,45)	1.500 (38,10)	2.250 (57,15)	N.A.	N.A.
200	.500 (12,70)	1.500 (38,10)	2.100 (53,34)	1.500 (38,10)	2.600 (66,04)	2.000 (50,80)	2.500 (63,50)
250	.625 (19,87)	N.A.	N.A.	2.000 (50,80)	2.500 (63,50)	2.000 (50,80)	2.500 (63,50)
550	.709 (18,00)	N.A.	N.A.	2.300 (58,42)	3.100 (78,74)	2.300 (58,42)	3.100 (78,74)
300	.187 (4,75)	0.850 (21,60)	1.500 (38,10)	0.850 (21,60)	1.500 (38,10)	N.A.	N.A.

N.A. - Not Available

Motor Couplings

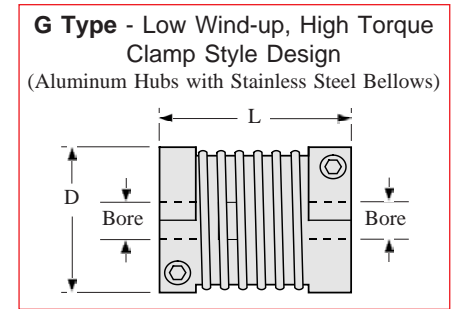
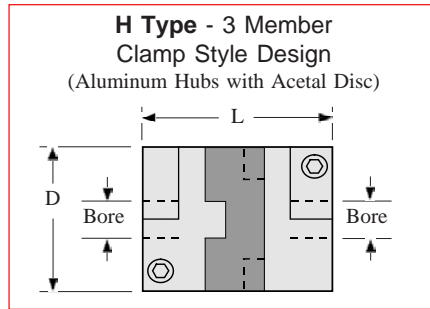
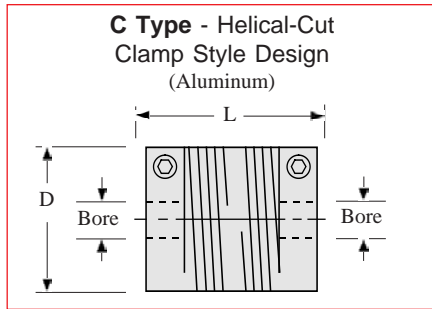

Model #	D inches (mm)	L inches (mm)	Table	Bore Diameters				Weight ounces (grams)	Inertia oz-in ² (g-cm ²)	Wind-up arc-sec/oz-in (deg/N-m)	Max Torque oz-in (N-m)
				Motor	Minimum (in) (mm)	Maximum (in) (mm)					
C075-xxx-aaa	0.75 (19,1)	1.00 (25,4)	xxx	aaa	.187 5	.250 8	0.8 (23)	0.06 (10)	45.0 (1,8)	200 (1,4)	
C100-xxx-aaa	1.00 (25,4)	1.50 (38,1)	xxx	aaa	.250 6	.375 10	1.5 (43)	.19 (35)	23.0 (0,9)	400 (2,8)	
C125-xxx-aaa	1.25 (31,8)	2.00 (50,8)	xxx	aaa	.250 6	.500 14	3.5 (99)	.68 (124)	15.0 (0,59)	700 (4,9)	
C150-xxx-aaa	1.50 (38,1)	2.37 (60,2)	xxx	aaa	.375 10	.625 16	5.5 (156)	1.54 (282)	13.0 (0,51)	950 (6,7)	
H075-xxx-aaa	0.75 (19,1)	1.02 (25,9)	xxx	aaa	.187 5	.250 8	0.5 (14)	0.04 (6)	12.6 (0,50)	225 (1,5)	
H100-xxx-aaa	1.00 (25,4)	1.28 (32,5)	xxx	aaa	.250 6	.375 10	1.2 (34)	.15 (27)	7.2 (0,28)	450 (2,8)	
H131-xxx-aaa	1.31 (33,3)	1.89 (48,0)	xxx	aaa	.250 6	.625 16	2.9 (82)	.62 (114)	2.5 (0,098)	1,000 (7,1)	
H163-xxx-aaa	1.63 (41,4)	2.00 (50,8)	xxx	aaa	.375 10	.750 20	5.4 (153)	1.79 (328)	1.2 (0,047)	2,000 (14,1)	
H197-xxx-aaa	1.97 (50,0)	2.35 (59,7)	xxx	aaa	.375 10	.750 20	7.6 (215)	3.69 (674)	1.1 (0,043)	3,600 (25,4)	
H225-xxx-aaa	2.25 (57,2)	3.07 (78,0)	xxx	aaa	.500 12	1.000 24	13.1 (371)	8.29 (1516)	0.6 (0,024)	5,300 (37,4)	
G075-xxx-aaa	0.79 (20,0)	1.02 (26,0)	xxx	aaa	.187 5	.375 10	0.8 (22)	0.06 (11)	2.0 (0,079)	300 (2,1)	
G100-xxx-aaa	0.99 (25,2)	1.26 (32,0)	xxx	aaa	.250 6	.500 12	1.3 (36)	.16 (29)	1.0 (0,39)	500 (3,5)	
G126-xxx-aaa	1.26 (32,1)	1.62 (41,0)	xxx	aaa	.250 6	.625 16	2.7 (74)	.54 (99)	0.3 (0,012)	1,100 (7,7)	
G158-xxx-aaa	1.58 (40,2)	1.85 (47,0)	xxx	aaa	.375 10	.750 20	4.3 (120)	1.34 (245)	0.2 (0,008)	2,400 (17,0)	
G177-xxx-aaa	1.77 (45,0)	2.48 (63,0)	xxx	aaa	.375 10	.750 20	7.1 (200)	2.78 (508)	0.2 (0,008)	4,250 (30,0)	
G220-xxx-aaa	2.20 (56,0)	2.56 (65,0)	xxx	aaa	.500 12	1.000 24	10.6 (300)	6.41 (1172)	0.04 (0,002)	7,100 (50,0)	
G260-xxx-aaa	2.60 (66,0)	3.07 (78,0)	xxx	aaa	.625 16	1.000 24	21.2 (600)	17.91 (3276)	0.03 (0,001)	9,600 (68,0)	
Possible values for xxx & aaa	250 = .250 inch 375 = .375 inch 500 = .500 inch 625 = .625 inch	750 = .750 inch 999 = 1.000 inch	005 = 5 mm 006 = 6 mm 008 = 8 mm 009 = 9 mm	010 = 10 mm 011 = 11 mm 012 = 12 mm 014 = 14 mm	016 = 16 mm 018 = 18 mm 019 = 19 mm	020 = 20 mm 024 = 24 mm					

Linear & Rotary Incremental Encoders

Linear Encoders: If a linear encoder is supplied by *LINTECH*, it comes mounted & aligned to the positioning table. This encoder operates via an LED pickup of an etched strip on a glass spar which spans the entire length of the encoder. **WARNING - It is important NOT to make any adjustments to the encoder mounting.** The encoder alignment is extremely critical and is important for proper accuracy, repeatability, and performance. The warranty is voided if adjustments are made to any part of the encoder or encoder mounting.

Rotary Encoders: If a rotary encoder is supplied by *LINTECH*, it comes installed on the table opposite the motor mount end. This rotary encoder is shaftless and is physically mounted to the screw shaft or drive shaft extension on a belt drive table. **WARNING - It is important NOT to remove the rotary encoder from the positioning table.** The glass disk is pre-aligned by *LINTECH* for proper operation. Removing the encoder could effect its performance. The encoder is protected with a sheet metal cover, which is not totally sealed. Therefore if splashing fluid, or other materials is present, precautions should be made to redirect these items away from the encoder housing since contaminants which penetrate the housing can cause encoder failure.

Linear Encoder - Screw Driven Tables

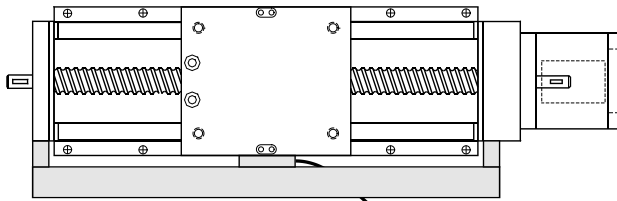

10 foot (3 m) shielded cable, with 12 pin DIN connector; (mating DIN connector provided)

Note: The encoder read head is mounted to the table carriage with the encoder lip seal facing down.

Notes:

When using a linear encoder, the user can either use the mating connector which interfaces to the connector on the linear encoder, or just cut the connector that is on the encoder and use the wire chart on page 19 for wire color information.

Rotary Encoder - Screw Driven Tables

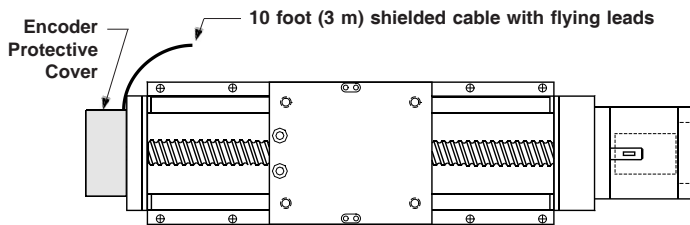

Rotary Encoder - Belt Driven Tables

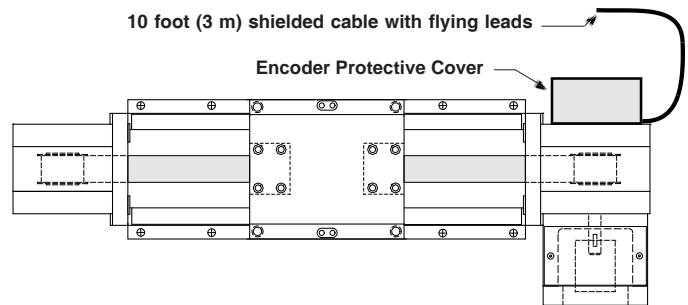

Linear & Rotary Incremental Encoders

Specification	ROTARY ENCODERS			LINEAR ENCODERS	
	E01 or RE-500	E02 or RE-1000	E03 or RE-1270	E10 or LE series	E11
Line Count	500 lines/rev	1000 lines/rev	1270 lines/rev	2500 lines/inch	125 lines/mm
Pre Quadrature Resolution	0.002 revs/pulse	0.001 revs/pulse	0.00079 revs/pulse	0.0004 inch/pulse	8 microns/pulse
Post Quadrature Resolution	0.0005 revs/pulse	0,00025 revs/pulse	0.00019 revs/pulse	0.0001 inch/pulse	2 micron/pulse
Accuracy				+/- 0.0002 in/40"	+/- 5 microns/m
Maximum Speed	50 revs/sec			79 inches/sec	2 m/sec
Maximum Accel	40 revs/sec ²			130 ft/sec ²	40 m/sec ²
Excitation Power	+ 5 VDC @ 125 ma			+ 5 VDC @ 150 ma	
Operating Temperature	32° F to 140° F (0° C to 60° C)			32° F to 120° F (0° C to 50° C)	
Humidity	20% to 80% non condensing			20% to 80% non condensing	
Shock	10 G's for 11 msec duration			15 G's for 8 msec duration	
Weight	0.7 lbs (0,283 kg)			0.7 oz/inch (0,00078 kg/mm) length of scale + 0.5 lbs (0,23 kg) read head and brackets	
Cable Length	10 ft (3 m), unterminated 26 gauge leads			10 ft (3 m) with DIN connector	
Zero Reference Output	Once per revolution			At center of encoder length	
Outputs	TTL square wave; Two channel (A+ & B+); Differential (A- & B-); Line Driver				

LINEAR		ROTARY	Description
Din Pin #	Wire Color	Wire Color	
C	Green	White	Channel A ⁺ (or A)
D	Yellow	Blue	Channel A ⁻ (or \bar{A})
E	Pink	Green	Channel B ⁺ (or B)
L	Red	Orange	Channel B ⁻ (or \bar{B})
G	Brown	White/Black	Channel Z ⁺ (or Z)
H	Grey	Red/Black	Channel Z ⁻ (or \bar{Z})
A	Shield		Case ground
B	White	Black	Common
K	Black	Red	+ 5 vdc (+/- 5%)

Notes:

- Both linear & rotary encoders are not totally sealed, and precautions should be taken to protect the encoder in corrosive or fluid splashing type of environments.
- DO NOT** remove linear or rotary encoders. Their mounting orientation is critical for proper operation. Encoders are adjusted by *LINTECH*, prior to shipping, for proper operation.

Power-Off Electric Brakes - Operation & Interface

This mechanical brake is primarily used in vertical ball screw (or belt drive) applications. Since a ball screw, and belt drive, are very efficient drive mechanisms, they will allow the positioning table's carriage/load to backdrive when motor power is off (for most applications). Thus, if a power-off electric brake is used, and properly interfaced with a position controller, it will hold the carriage in-place whenever motor power is off, or in case of a power failure. The brake is a "friction type" and is mounted to the screw (or belt drive) shaft extension on the end plate opposite the motor mount end. When power is applied to the brake, the brake is opened or "released". When power is removed, the brake is activated which prevents the carriage from moving, so long as the brake holding torque is greater than the backdriving force of the screw (or belt drive) with the attached load.

The brake comes with two wires for power (24 or 90 VDC). These should be wired directly to an external power supply, or user supplied relay network. In most cases, your motor drive and brake power should come from the same source. Thus, when the drive loses power, so will the brake. For stepper & servo systems, further interfacing is required to ensure power-off braking if a motor stalls or there is a drive fault. This requires an encoder to be interfaced to a position controller which will activate relays to remove brake power when a fault occurs. Below is a block diagram of a recommended interface. See the Positioning Systems catalog for further brake specifications.

Brakes

Table Series	Brake Model Number	Holding Force	Excitation Voltage	Current	Weight
		in-lbs (N-m)	volts	amps	lbs (kgf)
90, 100, 110, 120, 130, 140, 150, 160, 170, 180 and 610	B01 or BR-1-A	18 (2,0)	24 VDC	0.733	1.4 (0,62)
	B02 or BR-1-B	18 (2,0)	90 VDC	0.178	1.4 (0,62)
200	B03 or BR-2-A	84 (9,49)	24 VDC	0.973	2.1 (0,95)
	B04 or BR-2-B	84 (949)	90 VDC	0.239	2.1 (0,95)
250 and 550	B05 or BR-3-A	180 (20,3)	24 VDC	1.136	2.8 (1,27)
	B06 or BR-3-B	180 (20,3)	90 VDC	0.287	2.8 (1,27)

Power Supplies

Model Number	DC Output			AC Input		
	volts	amps	style	volts	amps	Hz
41970	5	3.0	regulated	120 / 240	0.8 / 0.4	47-63
37488	24	1.2	regulated	120 / 240	0.8 / 0.4	47-63
37489	90	0.8	unregulated	120	1.0	50/60
37490	90	0.8	unregulated	240	0.5	50/60

Note: The brake **MUST NOT** be engaged when the positioning table is in motion. Moving the table with the brake applied could damage the brake and the positioning table. Also, continuous use of the brake to stop a table (and load) that is in motion, could damage the brake.

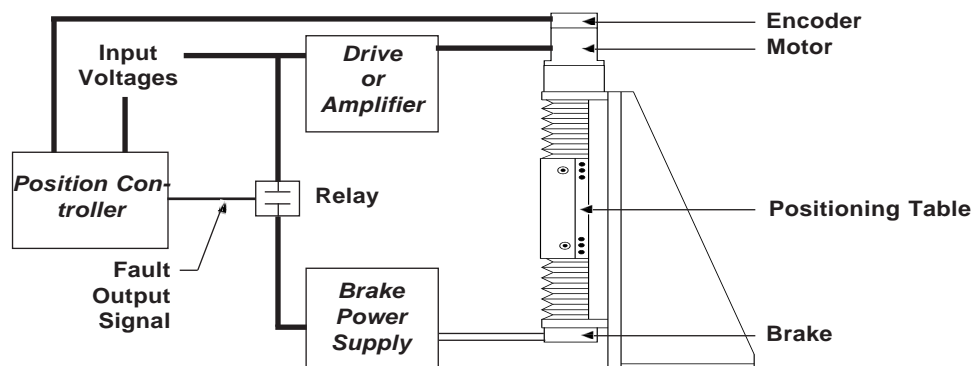

Switches - Mechanical, Magnetic Reed, Hall Effect, & Proximity

LINTECH provides two EOT (end of travel) switches and one HOME switch for each table (when ordered). The EOT switches will give a signal to the motor controller to stop motion immediately when activated (they protect the carriage from colliding with the table end plates). This protects the positioning table from mechanical damage, protects operating personnel from injury, and prevents the user mounted load from striking other components within the area. The home switch is placed just forward from the end of travel switch located at the motor mount end. This switch is used by the position controller as a known fixed mechanical location on the positioning table. It serves to synchronize the position controller with the positioning table electronically.

LINTECH can provide either mechanical or non-contact switches. See pages 22-23 of this Service Manual for detailed information on the different switches. The below diagrams show the general location of each switch. Depending on the table series, or custom system, the switches could be located "inside" or "outside" the positioning system. **It is highly recommended that any positioning table (standard or custom) used with a position controller, should have "END of TRAVEL" switches installed (and operating properly) for protection of personnel, table carriage, and user mounted load.**

Switch Locations (these are the normal locations - depends on table series and customer preference)

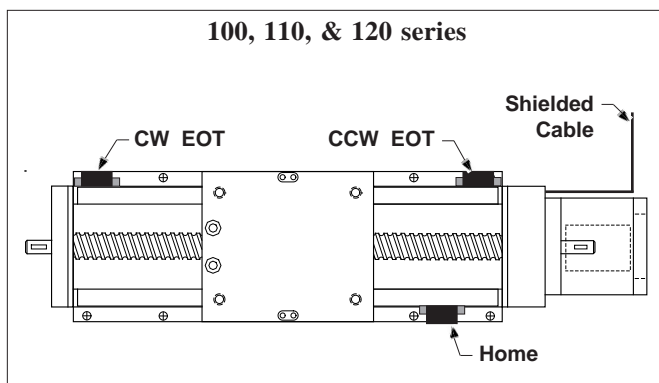
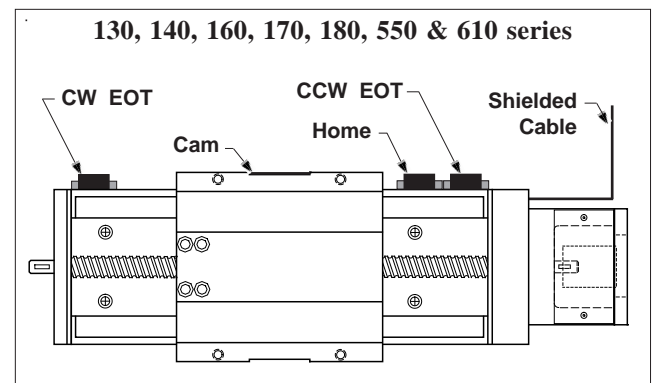
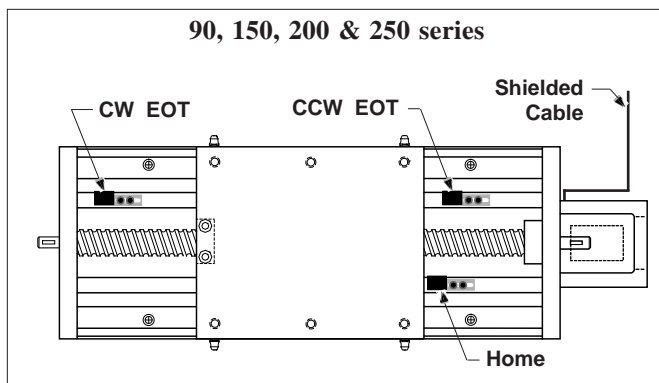

NOTES:

1. EOT switches are normally located inward from a positioning table's maximum travel hard stops. Thus, reducing the overall system travel from the listed table's travel lengths.
2. The CW and CCW switches are usually wired normally closed so the position controller can detect a broken wire.
3. When using the motor wrap option with any table, the CW & CCW designations should be reversed at the cable end for proper operation.

- CW - Clockwise
- CCW - Counter Clockwise
- EOT - End of Travel
- NC - Normally Closed
- NO - Normally Open

Switch location adjustments - depending on the table series, or custom positioning system, each switch is usually mounted to a bracket which in turn is mounted to the table base. The switch activation cam is either mounted to the lead screw nut assembly or the table carriage. The activation cam may have a magnet attached to it - depends on what type of switch is being used.

90, 150, 200 & 250 series - The switch mounting bracket usually has slotted mounting holes which allow approximately 0.75 inches of movement for the individual switch on the table base.

100, 110, 120, 130, 160, 170, 180, 550 & 610 series - The switch mounting bracket "snaps" into a T-slot that runs along the entire length of the table base. This allows the user to locate each switch anywhere on the positioning table. For the **100, 110, 120, 130 & 140 series** remove the mounting bracket by using a screw driver to "pry" out the bracket from one end - be careful not to damage the wires that run inside the T-slot. Reinsert the mounting bracket by placing the bottom of the bracket in the T-slot first & then "snapping" the top of the bracket in place. For the **160, 170, 180 550 & 610 series** remove the mounting bracket by loosening the set screws that lock the bracket in the T-slot.

EOT & Home Switch Wiring - Mechanical & Reed - Cable Version

Mechanical Switches:

Repeatability	: +/- 0.0002 inch (5 microns)
Electrical	: 5 amps @ 125 VAC 1 amp @ 85 VDC
Activation Style	: mechanical cam
Activation Area	: depends on table series from 0.5 inches (12,7 mm) to 1.75 inches (44,45 mm) of travel
Temperature Range	: - 25° C to + 85° C
Environment	: non wash down
Individual Switch Wiring	: none

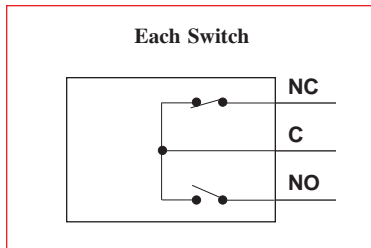

Standard *LINTECH* Wiring : from table end plate,
10 foot (3 m) shielded cable,
6 conductor, 24 AWG,
unterminated leads

Wire Color	Description
Black	CW EOT NC
Blue	CW Common
Red	CCW EOT NC
White	CCW Common
Brown	HOME NO
Green	HOME Common
Silver	Shield

CW - Clockwise
CCW - Counter Clockwise
EOT - End of Travel
NC - Normally Closed
NO - Normally Open

Non-Contact Reed Switches:

Repeatability	: +/- 0.0020 inch (50 microns)
Electrical	: 1.0 amps @ 125 VAC 0.5 amps @ 100 VDC
Activation Style	: magnetic
Activation Area	: 0.30 inches (7,62 mm) of travel
Temperature Range	: - 10° C to + 60° C
Environment	: non wash down
Individual Switch Wiring	: 12 inch (305 mm) leads

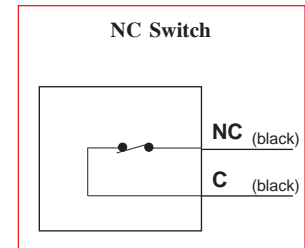
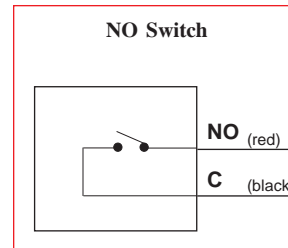

Standard *LINTECH* Wiring : from table end plate,
10 foot (3 m) shielded cable,
6 conductor, 24 AWG,
unterminated leads

Wire Color	Description
Black	CW EOT NC
Blue	CW Common
Red	CCW EOT NC
White	CCW Common
Brown	HOME NO
Green	HOME Common
Silver	Shield

CW - Clockwise
CCW - Counter Clockwise
EOT - End of Travel
NC - Normally Closed
NO - Normally Open

NC switch - red dot marker
NO switch - green dot marker

EOT & Home Switch Wiring - Hall Effect & Proximity - Cable Version

Non-Contact Hall Effect Switches:

- Repeatability : +/- 0.0002 inch (5 microns)
- Electrical : 5 - 24 VDC
15 mA - power input
25 mA max - signal
- Actuation Style : magnetic
- Activation Area : 0.32 inches (8,13 mm) of travel

- Temperature Range : - 10° C to + 60° C
- Environment : wash down
- Individual Switch Wiring : 12 inch (305 mm) leads

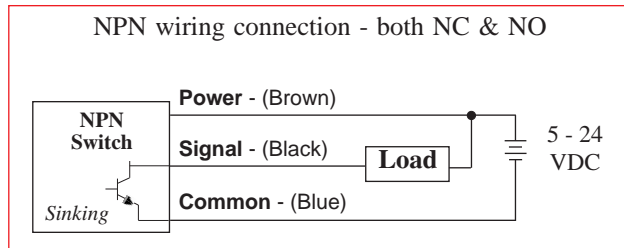

Standard *LINTECH* Wiring : from table end plate, 10 foot (3 m) shielded cable; 9 conductor, 24 AWG, unterminated leads

Wire Color	Description		
Brown	CW Power	(brown)	switch NC
Black	CW EOT	(black)	
Blue	CW Common	(blue)	
Red	CCW Power	(brown)	switch NC
White	CCW EOT	(black)	
Green	CCW Common	(blue)	
Orange	Home Power	(brown)	switch NO
Yellow	Home	(black)	
Grey	Home Common	(blue)	
Silver	Shield		

CW - Clockwise
 CCW - Counter Clockwise
 EOT - End of Travel
 NC - Normally Closed
 NO - Normally Open

NC switch - red dot marker
 NO switch - green dot marker

Non-Contact Proximity Switches - "CE":

- Repeatability : +/- 0.0002 inch (5 microns)
- Electrical : 10 - 28 VDC
15 mA - power input
100 mA max - signal
- Actuation Style : non-magnetic cam
- Activation Area : depends on table series
from 0.5 inches (12,7 mm) to
1.75 inches (44,45 mm) of travel

- Temperature Range : - 25° C to + 75° C
- Environment : IEC IP67 wash down
- Individual Switch Wiring : 6.5 foot (2 m) cable for NPN
3.3 foot (1 m) cable for PNP

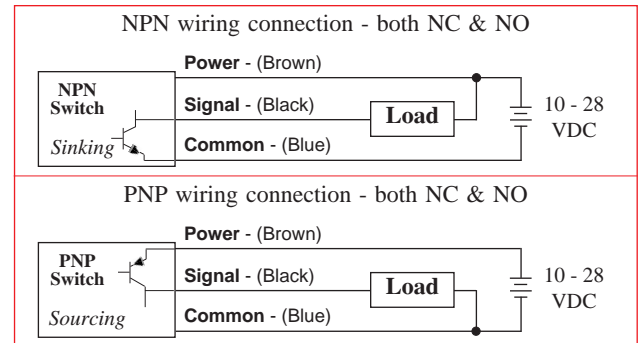

Standard *LINTECH* Wiring : from table end plate, 10 foot (3 m) shielded cable; 9 conductor, 24 AWG, unterminated leads

Wire Color	Description		
Brown	CW Power	(brown)	switch NC
Black	CW EOT	(black)	
Blue	CW Common	(blue)	
Red	CCW Power	(brown)	switch NC
White	CCW EOT	(black)	
Green	CCW Common	(blue)	
Orange	Home Power	(brown)	switch NO
Yellow	Home	(black)	
Grey	Home Common	(blue)	
Silver	Shield		

CW - Clockwise
 CCW - Counter Clockwise
 EOT - End of Travel
 NC - Normally Closed
 NO - Normally Open

NC switch - red dot marker
 NO switch - green dot marker

EOT & Home Switch Wiring - Mechanical & Reed - Connector Version

Mechanical Switches:

Repeatability	: +/- 0.0002 inch (5 microns)
Electrical	: 5 amps @ 125 VAC 1 amp @ 85 VDC
Activation Style	: mechanical cam
Activation Area	: 1.75 inches (44,45 mm) of travel
Temperature Range	: - 25° C to + 85° C
Environment	: non wash down
Added Table Width	: 0.063 inch (1,6 mm) (EOT switches) 0.063 inch (1,6 mm) (Home switch)

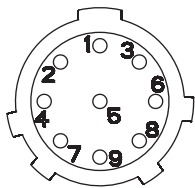
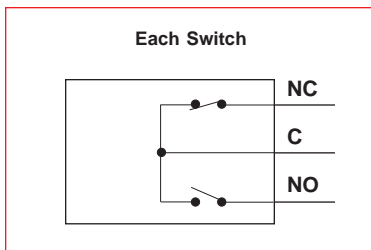

Standard *LINTECH* Wiring
(provided with switch option)

Female connector wired to:
10 foot (3 m) shielded cable,
6 conductor, 24 AWG,
unterminated leads

Pin	Wire Color	Description
2	Black	CW EOT NC
3	Blue	CW Common
5	White	CCW EOT NC
6	Green	CCW Common
8	Yellow	HOME NO
9	Grey	HOME Common
	Silver	Shield

Non-Contact Reed Switches:

Repeatability	: +/- 0.0020 inch (50 microns)
Electrical	: 1.0 amps @ 125 VAC 0.5 amps @ 100 VDC
Activation Style	: magnetic
Activation Area	: 0.30 inches (7,62 mm) of travel
Temperature Range	: - 10° C to + 60° C
Environment	: non wash down
Added Table Width	: 0.063 inch (1,6 mm) (EOT switches) 0.063 inch (1,6 mm) (Home switch)

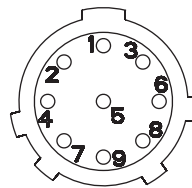
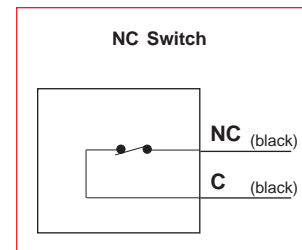
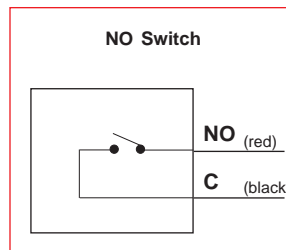

Standard *LINTECH* Wiring
(provided with switch option)

Female connector wired to:
10 foot (3 m) shielded cable,
6 conductor, 24 AWG,
unterminated leads

Pin	Wire Color	Description
2	Black	CW EOT NC
3	Blue	CW Common
5	White	CCW EOT NC
6	Green	CCW Common
8	Yellow	HOME NO
9	Grey	HOME Common
	Silver	Shield

Note: Hermetically sealed mechanical switches can be ordered as an option. This may be desired for "wash down" applications. Contact *LINTECH*.

EOT & Home Switch Wiring - Hall Effect & Proximity - Connector Version

Non-Contact Hall Effect Switches:

Repeatability	: +/- 0.0002 inch (5 microns)
Electrical	: 5 - 24 VDC 15 mA - power input 25 mA max - signal
Actuation Style	: magnetic
Activation Area	: 0.32 inches (8,13 mm) of travel
Temperature Range	: - 10° C to + 60° C
Environment	: wash down
Added Table Width	: 0.063 inch (1,6 mm) (EOT switches) 0.063 inch (1,6 mm) (Home switch)

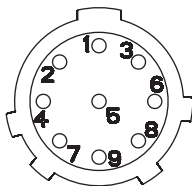
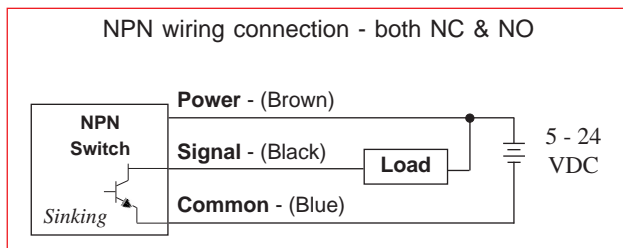

Standard *LINTECH* Wiring
(provided with switch option)

Female connector wired to:
10 foot (3 m) shielded cable,
9 conductor, 24 AWG,
unterminated leads

Pin	Wire Color	Description		
1	Brown	CW Power	(brown)	switch NC
2	Black	CW EOT	(black)	
3	Blue	CW Common	(blue)	
4	Red	CCW Power	(brown)	switch NC
5	White	CCW EOT	(black)	
6	Green	CCW Common	(blue)	
7	Orange	Home Power	(brown)	switch NO
8	Yellow	Home	(black)	
9	Grey	Home Common	(blue)	
	Silver	Shield		

Non-Contact Proximity Switches - "CE":

Repeatability	: +/- 0.0002 inch (5 microns)
Electrical	: 10 - 28 VDC 15 mA - power input 100 mA max - signal
Actuation Style	: non-magnetic cam
Activation Area	: 1.75 inches (44,45 mm) of travel
Temperature Range	: - 25° C to + 75° C
Environment	: IEC IP67 wash down
Added Table Width	: 0.20 inch (5,1 mm) (EOT switches) 0.20 inch (5,1 mm) (Home switch)

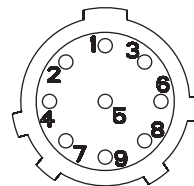
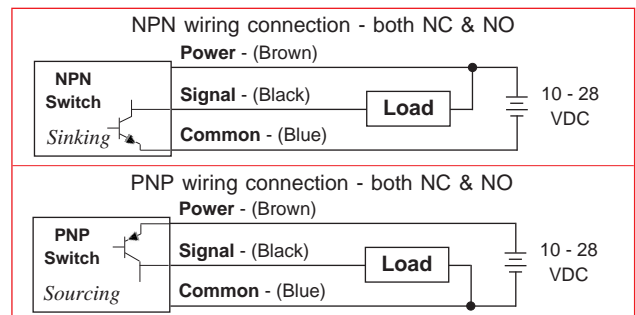

Standard *LINTECH* Wiring
(provided with switch option)

Female connector wired to:
10 foot (3 m) shielded cable,
9 conductor, 24 AWG,
unterminated leads

Pin	Wire Color	Description		
1	Brown	CW Power	(brown)	switch NC
2	Black	CW EOT	(black)	
3	Blue	CW Common	(blue)	
4	Red	CCW Power	(brown)	switch NC
5	White	CCW EOT	(black)	
6	Green	CCW Common	(blue)	
7	Orange	Home Power	(brown)	switch NO
8	Yellow	Home	(black)	
9	Grey	Home Common	(blue)	
	Silver	Shield		

300 Series Rotary Positioning Table

LINTECH's 300 series rotary positioning table uses a low backlash precision worm gear drive system and is designed for light industrial applications. The user mounting surface needs to be **flat to (0.001 in/ft)** in order to achieve the published operating specifications of the 300 series. The circular table top can be removed for modification if desired. The base section houses the rotary bearing elements and should under no circumstances be disassembled. **Modifying or dismantling the base section will VOID the warranty of any 300 series positioning table.**

Customer adapter plates should not be 50% greater than the table top diameter (example: table top diameter 8" - max customer adapter plate 12"). Care should be taken when mounting additional items to a customer adapter plate. Heavy items need to be precisely balanced on the adapter plate so as to not introduce additional dynamic forces to the table when moving. **Exceeding recommended load capacity can permanently damage a 300 series table.**

The plastic cover on the top of the base section can be removed for mounting of a user supplied motor. The cover should be replaced as it protects the motor coupling area from external contaminants. Use a Lincoln needle fitting #5803, or equivalent, on the external grease fitting which is located on the base section. Use only #2 LITHIUM grease as a lubricant. Lubricate on a regular basis but DO NOT over lubricate.

Non-Contact Reed Switches

- Repeatability : +/- 100 arc-sec
- Electrical : 1.0 amps @ 125 VAC
0.5 amps @ 100 VDC
- Activation Style : magnetic
- Activation Area : 0.30 inches (7,62 mm) of travel
- Temperature Range : - 10° C to + 60° C
- Environment : non wash down
- Individual Switch Wiring : 12 inch (305 mm) leads

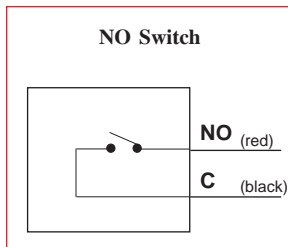

Non-Contact Hall Effect Switches

- Repeatability : +/- 10 arc-sec
- Electrical : 5 - 24 VDC
15 mA - power input
25 mA max - signal
- Actuation Style : magnetic
- Activation Area : 0.32 inches (8,13 mm) of travel
- Temperature Range : - 10° C to + 60° C
- Environment : wash down
- Individual Switch Wiring : 12 inch (305 mm) leads

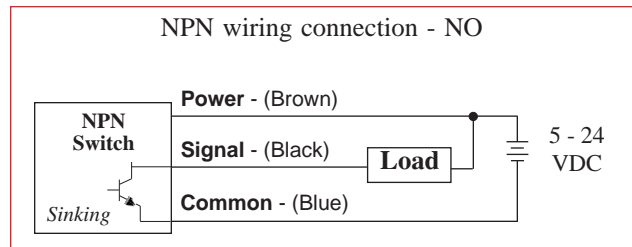

Standard LINTECH Wiring : from table,
(provided when switch option is 10 foot (3 m) shielded cable,
ordered with any table) 6 conductor, 24 AWG,
unterminated leads

Pin #	Wire Color	Description
7	Brown	HOME (red) NO
8	Green	HOME Common (black)
3	Silver	Shield

Standard LINTECH Wiring : from table,
(provided when switch option is 10 foot (3 m) shielded cable;
ordered with any table) 9 conductor, 24 AWG,
unterminated leads

Pin #	Wire Color	Description
5	Orange	Home Power (brown)
7	Yellow	Home (black) switch NO
8	Grey	Home Common (blue)
3	Silver	Shield

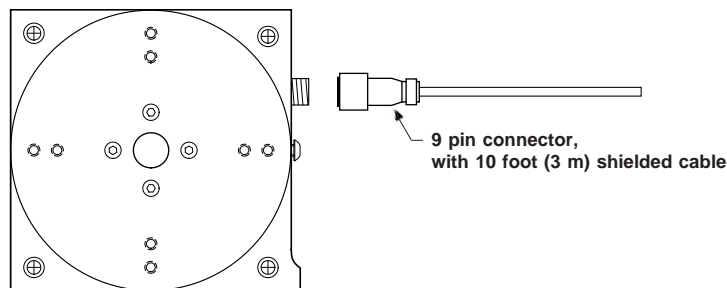

400 Series Rotary Positioning Table

LINTECH's 400 series rotary positioning table uses a low backlash precision bronze and steel worm gear drive system and is designed for heavier duty industrial applications. The rigid pair of 4 point contact radial ball bearings will produce smooth table top rotation. The motor adapter bracket can only accommodate a NEMA 34 size step motor or servo motor with either a 3/8" or 1/2" diameter shaft. The adapter bracket has a bushing which requires a #304 Woodruff key installed on the motor shaft for proper coupling.

The motor adapter bracket is coupled to the worm gear drive using a belt & pulley system. The adapter bracket can be mounted on either side of the belt & pulley system by changing the NEMA 34 bracket from one side to the other. The belt & pulley system can be mounted to two different sides of the rotary table base and also can be rotated 360° around its connection point to the table base. This arrangement allows the user to locate their motor in a number of different orientations.

To change the NEMA 34 bracket on the belt & pulley system from one side of "B" to the other:

- 1) Remove the 2 "C" Flat Head socket cap screws on the belt & pulley system below.
- 2) Locate and mount the NEMA 34 bracket to the other side of the belt & pulley system.

To rotate the belt & pulley system around side "B" below:

- 1) Loosen the "D" Socket Head cap screw on the table (located on the drawings below).
- 2) The belt & pulley system will now rotate 360° around side "B".
- 3) Retighten the "D" Socket Head cap screw after locating the belt & pulley position.

To locate the belt & pulley system from side "B" to side "A" below:

- 1) Loosen the "D" Socket Head cap screws on the table (located on the drawings below).
- 2) Remove the belt & pulley system by lightly tapping with a rubber hammer.
- 3) Locate the belt & pulley system to side "A" and retighten the "D" Socket Head cap screws.

Lubrication - No lubrication of the worm gear drive or belt & pulley system is required.

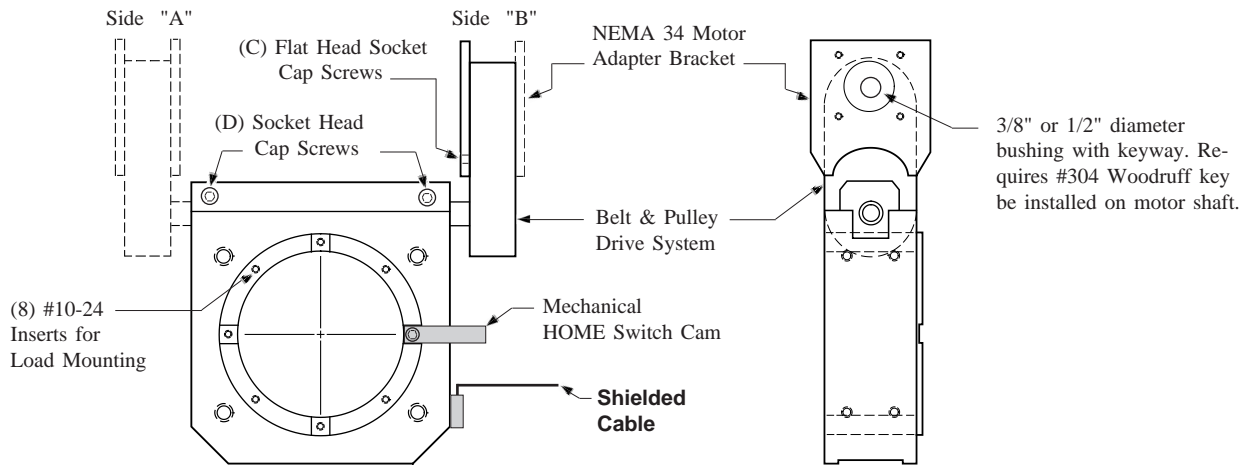

Mechanical Switch

- Repeatability : +/- 10 arc-sec
- Electrical : 5 amps @ 125 VAC
1 amp @ 85 VDC
- Activation Style : mechanical cam
- Activation Area : 0.5 inches (12.7 mm) of travel
- Temperature Range : - 25° C to + 85° C
- Environment : non wash down
- Individual Switch Wiring : none

Wire Color	Description
Brown	HOME 
Green	HOME Common
Silver	Shield

Standard LINTECH Wiring (provided when switch option is ordered with any table)

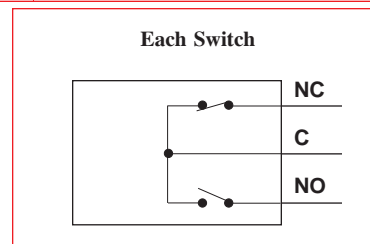

: from table, 10 foot (3 m) shielded cable, 6 conductor, 24 AWG, unterminated leads

Unit Conversions

Torque Conversions

Present Units	Convert To	Multiply By
Gram-centimeters	newton-meters -----	0.0000981
Gram-centimeters	ounce-inches -----	0.0138874
Gram-centimeters	pound-inches -----	0.000868
Gram-centimeters	pound-feet -----	0.0000723
Newton-meters	gram-centimeters ----	10,197.162
Newton-meters	ounce-inches -----	141.612
Newton-meters	pound-inches -----	8.85
Newton-meters	pound-feet -----	0.73756
Ounce-inches	gram-centimeters ----	72.0077
Ounce-inches	newton-meters -----	0.007062
Ounce-inches	pound-inches -----	0.0625
Ounce-inches	pound-feet -----	0.005208
Pound-inches	gram-centimeters ----	1,152.0
Pound-inches	newton-meters -----	0.11299
Pound-inches	ounce-inches -----	16.0
Pound-inches	pound-feet -----	0.08333
Pound-feet	gram-centimeters ----	13,825.5
Pound-feet	newton-meters -----	1.3558
Pound-feet	ounce-inches -----	192.0
Pound-feet	pound-inches -----	12.0

Distance Conversions

Present Units	Convert To	Multiply By
Arc-minutes	degrees -----	0.016666
Arc-seconds	degrees -----	0.000277
Centimeters	inches -----	0.3937
Centimeters	feet -----	0.03280
Centimeters	microns -----	10,000.0
Degrees	arc-minutes ----	60.0
Degrees	arc-seconds ----	3,600.0
Degrees	radians -----	0.017453
Feet	centimeters -----	30.48
Feet	meters -----	0.3048
Inches	centimeters ----	2.54
Inches	Km -----	0.0000254
Inches	meters -----	0.0254
Inches	microns -----	25,400.0
Inches	millimeters ----	25.4
Km	inches -----	39,370.0
Meters	feet -----	3.2808
Meters	inches -----	39.37
Meters	microns -----	1,000,000.0
Microns	centimeters ----	0.0001
Microns	inches -----	0.00003937
Microns	meters -----	0.000001
Microns	millimeters ----	0.001
Millimeters	inches -----	0.03937
Millimeters	microns -----	1,000.0
Radians	degrees -----	57.295779

Inertia Conversions

Present Units	Convert To	Multiply By
Gram-cm ²	ounce-inches ² ----	0.00546745
Gram-cm ²	ounce-inch-sec ² --	0.000014161
Gram-cm ²	pound-inches ² ----	0.000341716
Gram-cm ²	pound-inch-sec ² --	0.000000885
Gram-cm ²	pound-feet-sec ² --	0.000000074
Ounce-inches ²	gram-cm ² -----	182.901
Ounce-inches ²	ounce-inch-sec ² --	0.00259008
Ounce-inches ²	pound-inches ² ----	0.0625
Ounce-inches ²	pound-inch-sec ² --	0.00016188
Ounce-inches ²	pound-feet-sec ² --	0.00001349
Ounce-inch-sec ²	gram-cm ² -----	70,615.4
Ounce-inch-sec ²	ounce-inches ² ----	386.0
Ounce-inch-sec ²	pound-inches ² ----	24.13045
Ounce-inch-sec ²	pound-inch-sec ² --	0.0625
Ounce-inch-sec ²	pound-feet-sec ² --	0.00520833
Pound-inches ²	gram-cm ² -----	2,926.41
Pound-inches ²	ounce-inches ² ----	16.0
Pound-inches ²	ounce-inch-sec ² --	0.0414413
Pound-inches ²	pound-inch-sec ² --	0.00259008
Pound-inches ²	pound-feet-sec ² --	0.00021584
Pound-inch-sec ²	gram-cm ² -----	1,129,850.0
Pound-inch-sec ²	ounce-inches ² ----	6,177.4
Pound-inch-sec ²	ounce-inch-sec ² --	16.0
Pound-inch-sec ²	pound-inches ² ----	386.0
Pound-inch-sec ²	pound-feet-sec ² --	0.0833333
Pound-feet-sec ²	gram-cm ² -----	13,558,200.0
Pound-feet-sec ²	ounce-inches ² ---	74,128.9
Pound-feet-sec ²	ounce-inch-sec ² --	192.0
Pound-feet-sec ²	pound-inches ² ---	4,633.06
Pound-feet-sec ²	pound-inch-sec ² -	12.0

Load Conversions

Present Units	Convert To	Multiply By
Grams	newtons -----	0.009806
Grams	ounces -----	0.03528
Grams	pounds -----	0.002204
Kilograms	pounds -----	2.2046
Newtons	grams -----	101.971
Newtons	ounces -----	3.59692
Newtons	pounds -----	0.224808
Ounces	grams -----	28.3495
Ounces	newtons -----	0.27802
Ounces	pounds -----	0.0625
Pounds	grams -----	453.592
Pounds	kilograms -----	0.45359
Pounds	newtons -----	4.44824
Pounds	ounces -----	16.0
Pounds	tons -----	0.0005
Tons	pounds -----	2,000.0

Reference : Handbook of Tables for Applied Engineering Science

Terms of Sale

To Order

Any standard, or custom, product from *LINTECH* may be ordered by mail, email, on-line, phone, or fax from an Automation Specialist in your area. To obtain the name of your local Automation Specialist call:

LINTECH®

1845 Enterprise Way
Monrovia, CA 91016

Toll Free: (800) 435 - 7494

Phone: (626) 358 - 0110

Fax: (626) 303 - 2035

Web Site: www.LintechMotion.com

E-Mail: Lintech@LintechMotion.com

All required options should be reviewed using the part numbering guide for each model series. Your local Automation Specialist or factory personnel can assist you with any questions you may have.

Delivery

All shipping promises are made in good faith. Any shipping dates appearing on acknowledgments of orders or given to a customer in any other manner are approximate. Where the customer delays in supplying information necessary to proceeding with an order, the date of shipment may be extended accordingly. Standard products from *LINTECH* are usually available for delivery within 1 to 6 weeks of receipt of a purchase order. However, component shortages, labor disputes, or any other unforeseen circumstance may delay the delivery of an order. *LINTECH* shall not be held liable under any circumstance. All products are shipped F.O.B. Monrovia, CA. *LINTECH* packages all standard and custom products carefully. However, *LINTECH* is not liable for damage incurred during shipment. Contact the carrier immediately if damage to a package or shipment is noticed upon receipt of such shipment.

Payment Terms

Unless otherwise specified, payment shall be made by C.O.D, credit card (AMEX, Visa, or Master Card), or net thirty (30) days (pending credit approval) from date of shipment of the items purchased hereunder in U.S. currency. *LINTECH* reserves the right to require deposit payments on non-standard items, customs, or product built to Buyer's designs or specifications. Amounts not timely paid shall bear interest at the rate of 1.5% for each month or a portion thereof that Buyer is late in making payments. No responsibility is assumed by *LINTECH* for damages arising from delivery delays, fires, strikes, material shortages, accidents, or any other cause whatsoever, and purchase orders are accepted subject only to these conditions irrespective of statements or stipulations on purchase orders.

Minimum Order Amount

LINTECH requires a minimum of \$30 List Price U.S. currency on all orders.

Warranty

All *LINTECH* products are guaranteed to be free from defects in material and workmanship, under normal use, for a period of one year after date of shipment. This warranty covers the repair or replacement of a product when it is sent prepaid to *LINTECH*. *LINTECH* does not assume liability for installation, abuse, alteration, insufficient application data provided for a design, or misuse of any positioning system. Products furnished by *LINTECH*, but not manufactured by *LINTECH* (motors, gearheads, encoders, amplifiers, etc....), are subject to the manufacturers standard warranty terms and conditions.

Returns

Any product requiring a return to *LINTECH* (for warranty or non-warranty repair) requires pre-approval from the factory prior to shipment. Contact the customer service department at (800) 435-7494 in order to obtain a RMA (Return Materials Authorization) number. At that time, please have your system Model & Serial numbers available, along with the reason for the return. The RMA number should be clearly marked on the returned package label and your packing list, or shipping document. Return product freight prepaid in its original package or one with comparable protection. *LINTECH* will not accept return shipments sent freight collect. Product damage incurred during return shipment, from poor packaging, will not be warranted by *LINTECH*. Keeping original packing materials is recommended until initial inspection and testing is completed.

Dimensions and Product Changes

Published dimensions shown in *LINTECH* catalogs are known to be accurate at time of printing. *LINTECH* shall not be held liable, under any circumstances, for any wrongly documented dimension or specification. Changes in design are made whenever *LINTECH* believes its products will improve by the change. No obligation to incorporate these changes in units manufactured prior to a change will be assumed.

Cancellations

All items entered for production and on which a cancellation is requested shall be paid for on the basis of actual cost of labor, materials, and supplies applied to the production of such items plus proper overhead expenses determined in accordance with good accounting practice, plus 25% of the total of such cost and expenses; provided that such cost and expense plus 25% shall in no case exceed 100% of the quoted price of original order. Upon cancellation, *LINTECH* may dispose of materials used in the manufacture of cancelled order as it sees fit.



Mechanical Motion Solutions

For over 44 years, *LINTECH*[®] has designed and manufactured numerous standard and custom mechanical motion control products that are used in a wide range of applications and markets. This document highlights cut to length round rail precision shafting, round rail linear bearings (with or without pillow blocks), steel & aluminum shaft supports, shaft assemblies (single & *TWINRAIL*[®]), *TWINRAIL*[®] carriage assemblies, profile rail linear bearings, rolled & ground ball screw assemblies, acme & ball screw driven actuators, belt driven slides, worm gear driven rotary tables, and a wide range of custom positioning assemblies.



1845 Enterprise Way
Monrovia, CA. 91016
Phone: (800) 435 - 7494
(626) 358 - 0110
Fax: (626) 303 - 2035

Web Site: www.LintechMotion.com
E-Mail: Lintech@LintechMotion.com

YOUR LOCAL AUTOMATION SPECIALIST: